

80 Series Printer

User Manual

Note: This equipment has been tested and found to comply with the limits for a Class B digital device, pursuant to Part 15 of the FCC Rules. These limits are designed to provide reasonable protection against harmful interference in a residential installation. This equipment generates, uses, and can radiate radio frequency energy, and if not installed and used in accordance with the instructions, may cause harmful interference to radio communications. However, there is no guarantee that interference will not occur in a particular installation. If this equipment does cause harmful interference to radio or television reception, which can be determined by turning the equipment off and on, the user is encouraged to try to correct the interference by one or more of the following measures:

- Reorient or relocate the receiving antenna.
- Increase the separation between the equipment and receiver.
- Connect the equipment into an outlet on a circuit different from that to which the receiver is connected.
- Consult the dealer or an experienced radio/TV technician for help.

changes or modifications not expressly approved by the party responsible for compliance could void the user's authority to operate the equipment.

This device complies with Part 15 of the FCC Rules. Operation is subject to the following two conditions:

- (1) this device may not cause harmful interference, and
- (2) this device must accept any interference received, including interference that may cause undesired operation.

This equipment complies with FCC radiation exposure limits set forth for an uncontrolled environment. This equipment should be installed and operated with a minimum distance of 20cm between the radiator & your body. This transmitter must not be co-located or operating in conjunction with any other antenna or transmitter.

Catalogue

I. Product Introduction.....	3
1.1 Warnings.....	3
1.2 Notice.....	3
II. Summary.....	4
Main Features.....	4
III. Specification.....	4
IV. Installation and Operation.....	7
4.1 Contents in the package.....	7
4.2 Printer Connection.....	7
4.3 Load the Paper Roll.....	9
V. Power Switch, Keystroke and Indicator Light.....	9
5.1 Power Switch.....	9
5.2 Keystroke and Indicator Light.....	9
5.3 Setting Printer Mode.....	10
5.4 Self-checking.....	11
5.5 Printer special features.....	11
5.5.1 WIFI features (WIFI Printer).....	11
5.5.2 Bluetooth features (Bluetooth Printer).....	11
5.5.3 Paper near end detection function(Alternative).....	12
5.5.4 Beeper and light alarm function(Alternative).....	12
VI. Cash Drawer Interface.....	12
VII. Printer Serial Port.....	13
VIII. Parallel Interface.....	14
IX. Printer Ethernet Port.....	14
X. Printer Maintenance.....	15
10.1 Print Head Maintenance.....	15
10.2 Sensor Maintenance.....	15
10.3 Print Roll Maintenance.....	16
XI. Fix the cutter stuck.....	16
XII. Fault treatment.....	17
12.1 When indicators light on the control board is out.....	17
12.2 The indicator light is on, while the printer can't work.....	17
i . Printer driver.....	17

I. Product Introduction

80 series printer is a POS direct thermal receipt printer with easy operation and high cost effective, which is widely used in supermarket, hospital, restaurant, bank, oil station, turnpike etc.

Safety Notice

Please read carefully and strict compliance with use of following instructions before operating the printer.

1.1 Warnings

Warning: Do not touch the cutter of printer.

Warning: The print head is heating component; do not touch it and its peripheral parts during the printing process or the print just ended.

Warning: Do not touch the surface of the print head and its connecting parts to avoid damage it.

1.2 Notice

- (1) The printer should be installed at a firm place and avoid it in vibration and shake.
- (2) **Do not use or store the printer in the location of high temperature, humidity or heavy pollution.**
- (3) The power adapter of printer should be connected to a properly grounded receptacle. Avoid using the same socket with other large electronic machines or the equipment which could cause the voltage fluctuation.
- (4) Do not let water or conductive material like metal get inside the printer, if it happens, please turn off the power supply immediately.
- (5) Printer could not be worked when there is no paper; otherwise it would seriously damage the print roll and the thermal print head.
- (6) Please disconnect the power supply if do not use the printer for a long time.
- (7) The user should not dismantle the printer by self for repairing or remolding.
- (8) Use only the standard power adapter supplied together with the printer.

-
-
- (9) In order to ensure the printing quality and extend the life of printer, please use the recommendatory thermal paper or the one which has the same quality.
- (10) Please make sure the power of printer is off when plugging the connecting line.
- (11) Please keep the user manual for reference when needed.

II. Summary





Main Features

- High print quality
- Low noise
- Supports cash drawer driver
- Exquisite and lightweight, Pretty outside design
- Reasonable structure, easy using
- the font could be magnified, bolded or underlined, and also the character line spacing and left and right spacing can be adjusted before printing.
- Supports the print of different density bitmap and download figure.
- To realize and call built-in and cartridge font high speed printing in driver printing (dot printing).
- Low power consumption and operation cost (No need ribbon or ink box)
- Emulation: ESC/POS

III. Specification

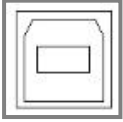
- **Printing Method:** Direct thermal printing
- **Paper Width:** 79.5±0.5mm
- **Effective Printing Width:** 72mm or 48mm
- **Receive the size of buffer :** Page mode 4KBytes
Non-page mode 1M (Alternative)
- **Printing Speed:** 250mm/s (300mm/s)
- **Print head performance**
Resolution: 576 dots/line
TPH: 150KM

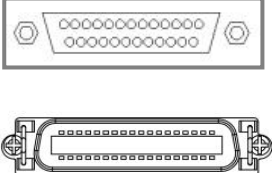
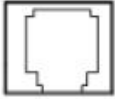
● **Interface:**

Pictorial View	Type	Notes
	USB	Universal USB interface (B standard)
	Serial Interface	DB9 female interface, baud rate can be 9600bps, 19200bps , 38400bps or 115200bps, .optional (can be adjusted via DIP switches). No parity data structure, 8 data bits, 1 stop bit, supports
	Parallel interface (25PIN) (36PIN)	25PIN/36PIN Parallel (male) bi-directional parallel interface, 8-bit parallel interface, support the BUSY/nAck handshake protocol.
	Ethernet interface	standard RJ45-8P interfaces, 10M/100M transmission speed adaptive, 100M internet LED indication , data communication LED indication.
	Cash Drawer control	6-wire RJ-11 socket, drive the cash drawer action via output DC 24V/1A signals.
	Power Port	Power plug DC24V.

The specific interface is according to the printer received actually.

- **Character**

ASCII code character set: 12×24 dots, 1.25 (W) ×3.00 (H) mm

Chinese character: 24×24 dots, 3.00 (W) ×3.00 (H) mm

International Code page: 50 types of international language--- PC437、Katakana、PC850、PC860、PC863、PC865、WPC1252、PC866、PC852、PC858 and so on.

Printing Barcode: Supports 11 types of barcode printing, CODEY、MSZ、UPC-A、UPC-E、EAN(JAN)13、EAN(JAN)8、CODE39、CODABAR、ITF、CODE93、CODE128 and so on.

- **Printing paper:**

Paper Type: Thermal paper

Recommendatory thermal paper:

Item #: AF50KS-E Manufacturer: Jujo Thermal Oy(Finland)

Item #: TF-50KS-E Manufacturer: Nippon Paper Industries Co., Ltd

Note

- (1) Suggest to using the recommendatory thermal paper or the one which has the same quality, otherwise, it would affect the printing result; even though, will shorten the life of thermal head.
 - (2) Don't use the paper roll which the end of paper is pasted at the axis core, it would cause the damage to the printer.
 - (3) If the thermal paper is polluted by the chemical or oil, it would fading or decreases the feeling of heat and influence the print result finally.
 - (4) It would result the fading of thermal paper if to use the hard material to chafe the surface.
 - (5) Please pay attention to the temperature, humidity and illumination of the storage for thermal paper. The paper would fade if the storage temperature is over 70 centigrade.
- **(MCBFM) Mechanical reliability:** 6×10^6 lines
 - **Emulation:** ESC/POS

Print Font: Support ANK. The font could be magnified, bolded or underlined and the user also could adjust the character spacing before printing.

Print Dot/Map: Supports the printing of different dots and graphic

- **Power Adapter**

Adapter Input: AC 110V/220V, 50~60Hz

Adapter Output: DC 24V/2.5A

Printer Input: DC 24V/2.5A

- **Environmental Adaption**

Operation Temperature: 0~50°C Operation Humidity: 10~80%

Storage Temperature: -10~50°C Storage Humidity: 10~90%

IV. Installation and Operation

4.1 Contents in the package

Please check the parts when opening the box, if there is something missed, please contact with the supplier or the manufacturer.

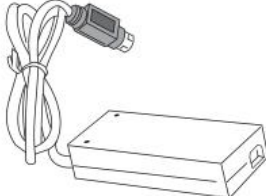
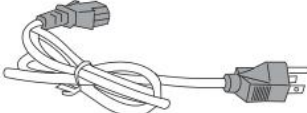
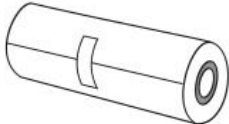
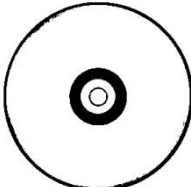
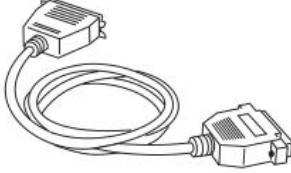
 Printer	 Power supplier	 Power cord
 Paper roll	 CD	 Communication cable

4.2 Printer Connection

- (1) To ensure the printer and PC is powered off and then insert the matched data connection lines to the interfaces (USB/Parallel/Serial) of the printer, the other ends are to the PC.

-
- (2) If the user fit out the electric opened cash drawer for the printer that could insert the RJ-11 connection line of it to the corresponding interface of the printer. (PS: The specification of cash drawer should be accorded with the driver requirement of printer).
 - (3) Connect to the supplied power adapter.
Please only use the supplied power adapter. Such as the following picture:

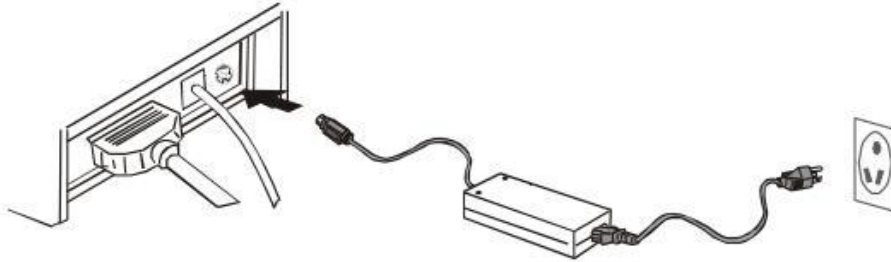

Notice:

- (1) Firstly, insert the power supply plug DC24V of printer; then connect the AC220V power; lastly, turn on the switch. Please operate it by the instruction steps; otherwise, it would damage the printer.
- (2) Using unsuitable power adapter would cause the bad print result; even may cause the breakdown of printer.
- (3) Do not connect the telephone line to the interface of cash drawer; because it may result in the damage for printer and telephone.
- (4) Do not pull the power soft wire when unplugging. If the user does it by force, it may result in the breakdown of the printer and power adapter.

4.3 Load the Paper Roll

Model: 80 printers, with easy paper loading, uses 80mm width thermal paper.

The loading instruction is listed as below:

- (1) Open the top cover of printer.
- (2) Load the thermal paper into printer as the following picture.
- (3) Pull a part of paper out and then close the top cover.

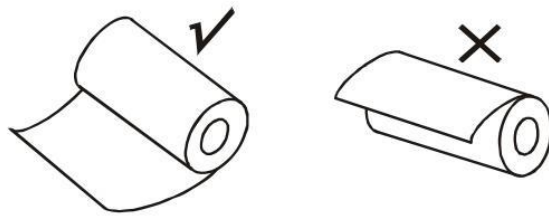

- (4) Use the cutter of printer to tear off the extra paper.

V. Power Switch, Keystroke and Indicator Light

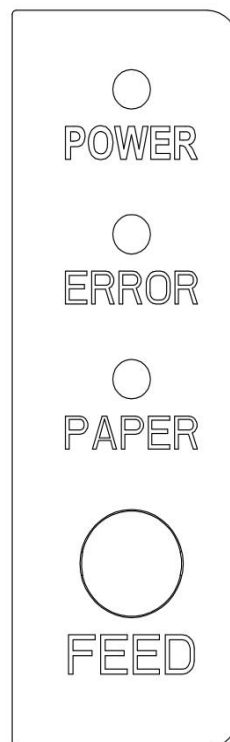

5.1 Power Switch

Switch is for turning on/off the power supply of printer which is located on the left. When pressing “-”, the printer turns on and when pressing “O”, it turns off.

Notice: Do not turn on the switch unless the user connects the power supply.

5.2 Keystroke and Indicator Light

Keystroke and indicator board is shown as below:

FEED Key:

In the standby status, the printer would be continuous feed when pressing the feed key. Of course, the key is inefficacy when the printer is working.

Press the feed key and switch on the power supply while the key is still under pressing, then the user could do the self-checking of printer.

POWER Key (Green) :

Light appears continuously when connected to the power supply.

ERROR Key (Red) :

Light appears under following condition:

Paperless, paper jam, print head overheat, print head error or other situations.

PAPER Key (Red) : Light appears when paperless.

5.3 Setting Printer Mode

80 printer is initially setup with default value. However, the default printer mode can be reconfigured to satisfy customer's needs through the DIP switch, which is located at the bottom of the printer.

The function of DIP switch setting as follows:

Switch	Function	(on)	(off)
1	cutter	No cutter	With cutter
2	Buzzing prompt	Open buzzing prompt	Close buzzing prompt
3	Printing density	High density	Regular density
4	24 bytes mode	No Chinese Character	With Chinese Character
5	Character per line	42	48
6	Select cash box	Open cash box	Close cash box
7-8	Transmission rate (apply for serial interface) (refer to below information)		
Transmission rate (bps) -bytes/s		SW-7	SW-8
38400		ON	ON
115200		OFF	ON
9600		ON	OFF
19200		OFF	OFF

5.4 Self-checking

Self-checking can test whether the printer is working well or not, if it can print The test list correctly, that means the printer is good enough (which is excluding the problem with the connected interface to PC); otherwise, it needs repair.

Self-checking could print software version number, print density, interface type, English character and some Chinese characters by order.

Self-checking procedure: Make sure the printer is connected to the power, then press the feed key and switch on the power supply while the key is still under pressing. At the same time, the printer begins to self-checking. Please loosen the key within five seconds and the printer would print the self-testing list after it.

5.5 Printer special features

5.5.1 WIFI features (WIFI Printer)

WiFi is a technology that allows electronic devices to be connected to a wireless local area network (WLAN). At present, printer uses 2.4G RF frequency band. Connected to a wireless LAN is usually a password protected; but it is also open, so that any device can be connected in the WLAN range.

If you need the actual WIFI setup steps, please refer to the "WIFI" settings in the integration tool settings specification.

5.5.2 Bluetooth features (Bluetooth Printer)

Bluetooth is a kind of radio technology that supports short range communication (usually 10m). Wireless information exchange can be carried out in a large number of devices including mobile phones, PDA, wireless headphones, laptop computers, peripherals, and so on. Printer Bluetooth standard is IEEE802.15, working in the 2.4GHz band, bandwidth of 1Mb/s.

The actual blue function setting step, please refer to the integration tool setting specification.

5.5.3 Paper near end detection function(Alternative)

When the paper is near to use out, the light coupling sensor can sense the status, on the printer up face PAPER light will turn on. The working principle is as follow: in the printer paper house, the paper roll height is higher than the height of the light coupling, means there is enough paper, the PAPER light will be off. The paper roll height is lower than the light coupling, means there is little paper, and the PAPER light will be on.

5.5.4 Beeper and light alarm function(Alternative)

When the paper still remains after the printing finished, the printer can detect the data via opt coupler and remind the current status with beeper and light alarm.

Currently only printers with beeper and light alarm function can support this function, other types of printers can't.

This function is no need manually set.

VI. Cash Drawer Interface

Cash drawer interface adopt RJ-11 standard, 6 lines socket and it outputs DC 24V/1A. Insert the RJ-11 socket to the corresponding interface which could through the printer to open the cash drawer.

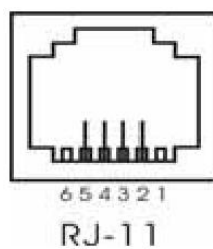

Pin function of cash drawer interface is listed as below:

Pin No.	Signal	Instruction
1	GND	Power ground
2	DK1	Cash box 1# cathode
3	DK-1N	Open detection
4	PWR	Power supply/cash box anode

5	DK2	Cash box 2# cathode
6	GND	Power ground

VII. Printer Serial Port

80 printer's serial port is RS-232 standard, and communication baud rate can be 9600bps, 19200bps, 38400bps or 115200bps optional (can be adjusted via DIP switches). It is 8 bits of data, no parity, 1 stop bit, support RTS / CTS and XON / XOFF handshake protocol.

The printer serial port pin functions are defined as follows:

Pin No.	Model Name	Signal Sources	Description
2	TXD	Printer	When using XON / XOFF handshake protocol, the printer will send control code XON / XOFF control code to the PC.
3	RXD	host	The printer is receiving data from the PC.
8	RTS	Pinter	This signal indicates the printer status. High signal reacts the printer "busy", and can not receive data. Low signal indicates the printer " ready " to receive data
5	GND	-----	Signal Ground
6	DTR	Printer	Same as the RTS signal (Pin 8)

Printer serial port and POS host serial interface connection diagram:

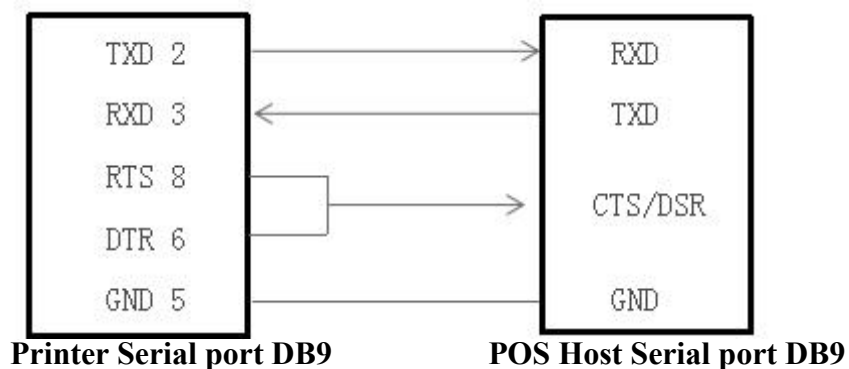

VIII. Parallel Interface

80 parallel interface is 25pin, 8 bit parallel transfers, supports BUSY/nAck handshake protocol.

Pin function of parallel interface is listed as below:

Pin number	Model	Signal Source	Specification
1	/STB	PC	Data strobe trigger pulse, data is read-in when falling edge.
2	DATA2	PC	These signals stand for the first to the eighth information of parallel data. Each signal when the logic shows "1" is high electrical level, when the logic shows "0" is low electrical level.
3	DATA3	PC	
4	DATA4	PC	
5	DATA5	PC	
6	DATA6	PC	
7	DATA7	PC	
8	DATA8	PC	
9	DATA9	PC	
10	nAck	Printer	Answer signal means the printer has received the data of previous byte.
11	BUSY	Printer	High electrical level means the printer is busy, could not receive data.
12	Paper-out	-----	Indicates whether the paper is missing Paper-out PE.
13	Select	Printer	The resistance pulls up high electrical level.
18-25	GND	-----	Electrical grounding, low electrical level.
15	NError(nFault)	Printer	The resistance pulls up high electrical level.

IX. Printer Ethernet Port

The Ethernet interface socket of 80 is RJ45-8P, support 10M/100M network, and the transmission speed is adaptive.

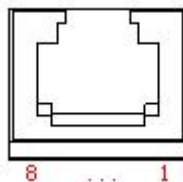

Pin No.	Description	Instruction
1	TX+	Send differential line
2	TX-	Send differential line

3	RX+	Receive differential line
4	NC	No function
5	NC	No function
6	RX-	Receive differential line
7	NC	No function
8	NC	No function

X. Printer Maintenance

10.1 Print Head Maintenance

When the printer has following circumstances, the user should clean the print head:

- (1) Printing is not clear;
- (2) Some longitudinal columns on the printing page is vague;
- (3) Loud noise when feeding.

Procedure of maintaining the print head is listed below:

- (1) Turn off the power supply and open the top cover. Remove the paper if necessary.
- (2) Please wait for the cooling of print head if it just finishes printing.
- (3) Use the cotton cloth and dip it in the absolute ethyl alcohol to clean the surface of print head.
- (4) When the absolute ethyl alcohol is completely volatilized, please close the top cover and restart the printer.

10.2 Sensor Maintenance

When the printer has following circumstance, the user should clean the paperless sensor:

- (1) During the printing, the printer occasionally stops print and the paperless alarm is beeping.
- (2) No paperless alarm.

Procedure of maintaining the sensor is listed below:

- (1) Turn off the power supply and open the top cover. Remove the paper if necessary.
- (2) Use the cotton cloth and dip it in the absolute ethyl alcohol to clean the surface of sensor.

-
- (3) When the absolute ethyl alcohol is completely volatilized, please close the top cover and restart the printer.

10.3 Print Roll Maintenance

When the printer has following circumstance, the user should clean the print roll:

- (1) Printing is not clear;
- (2) Some longitudinal columns on the printing page is vague;
- (3) Loud noise when feeding.

Procedure of maintaining the print roll is listed below:

- (1) Turn off the power supply and open the top cover.
- (2) Use the cotton cloth and dip it in the absolute ethyl alcohol to clean the surface of print roll.
- (3) When the absolute ethyl alcohol is completely volatilized, please close the top cover.

Notice:

- (1) The power supply of printer should be turned off when the routine maintenance.
- (2) Do not use hand or metal to touch the surface of print head and not use tweezers to scratch the superficiencies of print head, print roll or sensor.
- (3) Do not use oil or acetone to do the maintenance.
- (4) When the absolute ethyl alcohol is completed volatilized, then turn on the power to print.

XI. Fix the cutter stuck

In case that the cutter is stuck, the upper cover of the printer cannot be opened. The printer is powered off and restarted, and if the cutter stuck fails to reset, it needs to turn off the power, open the front cover of the printer (as shown in left picture) and stir the hand gear (the arrow position as shown in right picture) until the upper cover can be opened normally, namely, the cutter stuck problem is solved.

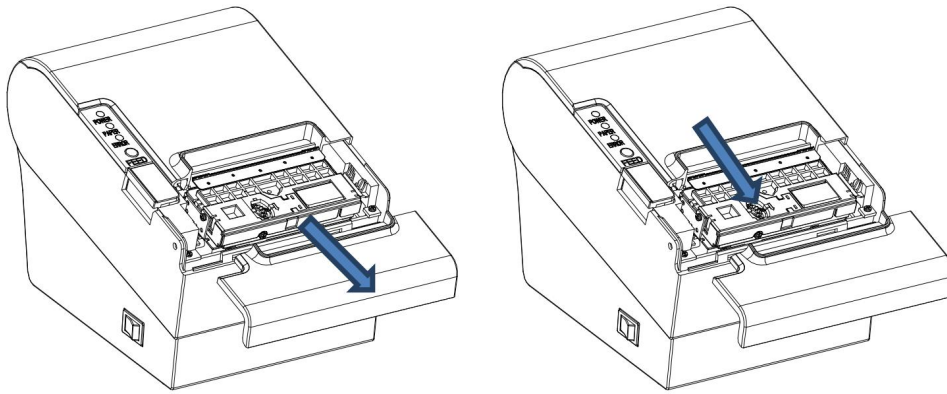

XII. Fault treatment

When the printer appears faults, please fix them correspondingly referring to this section. If it still can't work, please contact the distributor or manufacturer.

12.1 When indicators light on the control board is out

Check whether the power wire inserts the printer, power adaptor or power socket correctly. Check whether the power switch is on or off.

12.2 The indicator light is on, while the printer can't work

Do the self-checking to check whether the printer can work normally. If not, please contact the distributor or technical support.

If the self-checking can work, please check the following contents:

- (1) Check the interfaces of printer and computer and also check whether the connected line between them is to their specification requirement.
- (2) The setting of data transmission between printer and computer may be different. You know the printer's interface setting through the self-testing page. Please contact the agent or technical support if the printer cannot print.

i . Printer driver

Two types of drive for 80 Series: one is installed directly under Windows9x/7/8/10/ME/2000/XP/Linux/Mac, the other is to drive through Ethernet.

- (1) Install driver under Windows

Add printer in the Windows, and appoint the driver documents in the driver disk to Windows. It can print once you start print command in the program. In this way, Windows' printer driver turns characters to graphics dot-matrix for printing.

(2) Install driver by Interface

In this way, no need for drive program. It can print just when it output character to port and the hard font inside printer realizes the character exchange printing. By port for driver, the printing type transforms page printing to line printing, which controls printing more conveniently.

If you use port driver, it need instruction set to control printing of the printer, while 80 series have already integrated ESC/POS instruction set inside the printer.