

CM-520 Multi Function Bluetooth Barcode Scanner User manual.

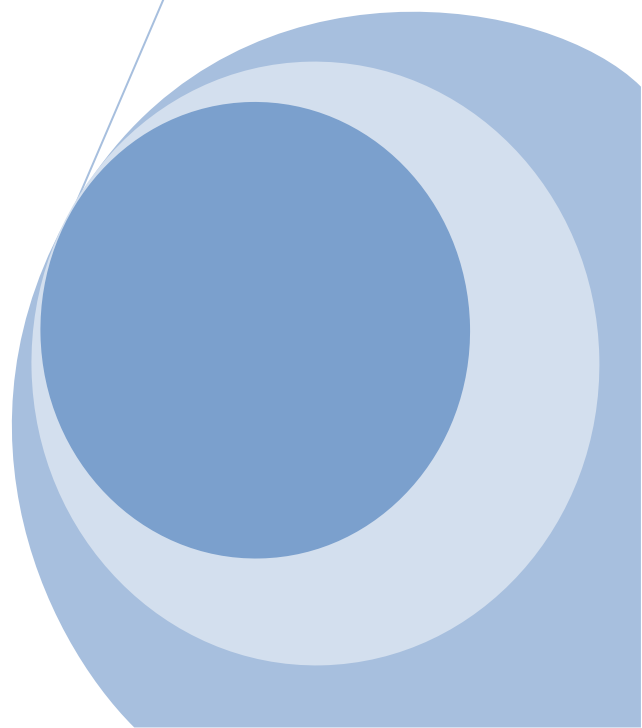

4-2-5-3 Pin Code	45
Chapter 5: Bluetooth Connection Mode Instruction	46
5-1 Slave mode Connection (For Third party Bluetooth devices).....	47
5-2 Master mode Connection (For third party Bluetooth Devices) ...	52
5-3 HID mode Connection (For Third party Bluetooth devices).....	57
5-4 HID iOS mode Connection	61
5-5 A-303 Dongle mode Connection(USB-HID / USB COM).....	65
5-5-1 HID mode.....	65
5-5-2 USB-COM mode.....	66
5-6 A-302 Dongle mode connection (USB-HID only).....	68
5-7 Spp-A303PT mode connection (USB-COM only)	69
Chapter 6: Memory / Bluetooth General Setting	70
6-1 General Memory Mode Setting	74
6-1-1 Mode.....	74
6-1-2 Output Interface.....	75
6-1-3 Scan Activation Time	76
6-1-4 Composite Triggers Functionality.....	76
6-1-5 Small Trigger Functionality.....	77
6-1-6 Battery Charge.....	77
6-1-7 Power Saving Time.....	78
6-1-8 Stand by Time.....	79
6-1-9 Headr/Footer.....	80
6-1-10 Date &Time Transmission.....	81
6-1-11 Date &Time Delimiter	81
6-1-12 Delimiter Content	82
6-1-13 Transmission Length.....	82
6-1-14 Reject Same	83
6-1-15 Good Read Beep.....	83
6-1-16 Warning Beep	84
6-1-17 Normal Beep.....	84
6-1-18 Good Read Vibrator.....	85
6-1-19 Warning Vibrator.....	85
6-1-20 Normal Vibrator.....	86
6-1-21 Viberator Time	86
6-1-22 Force Case	87
6-1-23 Transmission Code ID.....	87
6-1-24 Code ID Position.....	88
6-1-25 Transmission Code Name.....	88
6-1-26 Good Read Volume	89
6-1-27 Warning Beep Volume	89

6-1-28 Normal Volume	90
6-1-29 Double Confirm.....	90
6-1-30 Date/Time Position	91
6-1-31 Preamble Code.....	91
6-1-32 Preamble Content.....	92
6-1-33 Postamble Code	92
6-1-34 Postamble Content	93
6-1-35 Prefix Code.....	93
6-1-36 Prefix Content.....	94
6-1-37 Suffix Code	94
6-1-38 Suffix Content	95
6-1-39 Control Characters.....	95
6-1-40 Delimiter Code.....	96
6-1-41 Transmission Unit	96
6-1-42 Transmission Data All Delete	97
6-2 General Bluetooth Mode Setting	98
6-2-1 Mode.....	98
6-2-2 Output Interface.....	99
6-2-3 Scan Activation Time	100
6-2-4 Composite Triggers Functionality.....	100
6-2-5 Small Trigger Functionality.....	101
6-2-6 Battery Charge.....	101
6-2-7 Power Saving Time.....	102
6-2-8 Stand by Time.....	103
6-2-9 BT Pairing.....	103
6-2-10 BT Pairing Time	104
6-2-11 Good Read Beep	104
6-2-12 Warning Beep	105
6-2-13 Normal Beep.....	105
6-2-14 Good Read Vibrator.....	106
6-2-15 Warning Vibrator.....	106
6-2-16 Normal Vibrator.....	107
6-2-17 Viberator Time	107
6-2-18 Transmission Length.....	108
6-2-19 Force Case	108
6-2-20Transmission Code ID.....	109
6-2-21 Code ID Postition.....	109
6-2-22 Transmission Code Name.....	110
6-2-23 Good Read Volume	110
6-2-24 Warning Volume	111

6-2-25 Normal Volume	112
6-2-26 Beep Tone.....	113
6-2-27 Beep Time	113
6-2-28 Double Confirm.....	114
6-2-29 Date/Time Position	114
6-2-30 Preamble Code.....	115
6-2-31 Preamble Content.....	115
6-2-32 Postamble Code	116
6-2-33 Postamble Content	116
6-2-34 Prefix Code.....	117
6-2-35 Prefix Content.....	117
6-2-36 Suffix Code	118
6-2-37 Suffix Content	118
6-2-38 Control Characters.....	119
6-2-39 Delimiter Code.....	119
6-2-40 Delimiter Content.....	120
6-2-41 Reject Same	120
6-2-42 Date &Time Transmission.....	121
6-2-43 Date &Time Delimiter.....	121
6-3 General Cable Mode Setting	122
6-3-1 Mode.....	122
6-3-2 Output Interface.....	123
6-3-3 Scan Activation Time	123
6-3-4 Composite Triggers Functionality.....	124
6-3-5 Small Trigger Functionality.....	124
6-3-6 Battery Charge.....	125
6-3-7 Power Saving Time.....	125
6-3-8 Stand by Time.....	126
6-3-9 Date &Time Transmission.....	127
6-3-10 Date &Time Delimiter.....	127
6-3-11 Reject Same	128
6-3-12 Good Read Beep.....	128
6-3-13 Warning Beep.....	129
6-3-14 Normal Beep.....	129
6-3-15 Good Read Vibrator.....	130
6-3-16 Warning Vibrator.....	130
6-3-17 Normal Vibrator.....	131
6-3-18 Viberator Time	131
6-3-19 Transmission Length.....	132
6-3-20 Force Case	132

6-3-21	Transmission Code ID.....	133
6-3-22	Code ID Postition.....	133
6-3-23	Transmission Code Name.....	134
6-3-24	Good Read Volume	134
6-3-25	Warning Volume	135
6-3-26	Normal Volume	136
6-3-27	Beep Tone.....	137
6-3-28	Beep Time	137
6-3-29	Double Confirm.....	138
6-3-30	Date/Time Position	138
6-3-31	Preamble Code.....	139
6-3-32	Preamble Content.....	139
6-3-33	Postamble Code	140
6-3-34	Postamble Content	140
6-3-35	Prefix Code.....	141
6-3-36	Prefix Content.....	141
6-3-37	Suffix Code	142
6-3-38	Suffix Content	142
6-3-39	Control Characters.....	143
6-3-40	Delimiter Code.....	143
6-3-41	Delimiter Content.....	144
6-4	Scanner Confuguration by Software.....	145
6-4-1	Firmware Update	145
6-4-2	Scanner Configuration	150
Chapter 7:	General configuration setting	154
7-1	Host Interface.....	157
7-1-1	Version.....	157
7-1-2	Abort Setting	157
7-1-3	ISP Mode	158
7-1-4	Barcode Default.....	158
7-1-5	All Default	158
7-1-6	Mode Switch	159
7-2	Output Interface.....	160
	Cable Mode	160
7-2-1	USB-HID Keyboard Type.....	161
7-2-1-1	Caps Lock.....	161
7-2-1-2	Num Lock.....	162
7-2-1-3	Shift Release Caps Lock.....	162
7-2-1-4	Set OS	162
7-2-1-5	Transmission specific symbols Delay Time	163

7-2-1-6 Transmission Timeout	163
7-2-1-7 Transmission Char Delay	164
7-2-1-8 Transmission Char Gap Time.....	164
7-2-1-9 Transmission Record Gap Time	165
7-2-1-10 USB HID Layout Setting.....	165
7-2-2 USB-SPP(Virtual COM) Type.....	167
7-2-2-1 Length of Data Transfer Bit	167
7-2-2-2 Length of Data Stop Bit	167
7-2-2-3 Parity Check.....	168
7-2-2-4 Communication Protocol.....	168
7-2-2-5 <STX> & <ETX> Characters.....	169
7-2-2-6 <CMD> & <BAR> Characters	169
7-2-2-7 Command Mode	169
7-2-2-8 Baud Rate.....	170
7-2-2-9 Retransmission Count.....	171
7-2-2-10 ACK Timeout.....	172
7-2-2-11 Transmission specific symbols Delay Time	173
7-2-2-12 Transmission Timeout	173
7-2-2-13 Transmission Char Delay	174
7-2-2-14 Transmission Char Gap Time.....	174
7-2-2-15 Transmission Record Delay	175
Bluetooth Mode	176
7-2-3 Bluetooth HID Type.....	176
7-2-3-1 Caps lock	176
7-2-3-2 Num Lock.....	176
7-2-3-3 Bluetooth HID Layout Setting.....	177
7-2-3-4 Transmission specific symbols Delay Time	178
7-2-3-5 Transmission Timeout	178
7-2-3-6 Transmission Char Delay	179
7-2-3-7 Transmission Char Gap Time.....	179
7-2-3-8 Transmission Record Gap Time	180
7-2-4 Bluetooth-SPP Type.....	181
7-2-4-1 Communication Protocol.....	181
7-2-4-2 <STX> & <ETX> Characters.....	181
7-2-4-3 <CMD> & <BAR> Characters	182
7-2-4-4 Command Mode	182
7-2-4-5 Retransmission Count.....	183
7-2-4-6 ACK Timeout.....	183
7-2-4-7 Transmission specific symbols Delay Time	184
7-2-4-8 Transmission Timeout	184

7-2-4-9 Transmission Char Delay	185
7-2-4-10 Transmission Char Gap Time.....	185
7-2-4-11 Transmission Record Gap Time	186
7-3 System Control	187
7-3-1 Mode.....	187
7-3-2 System Beep Sw	187
7-3-3 Date Format.....	188
7-3-4 Time Format	188
7-3-5 Battery Chagre Speed	189
7-3-6 USB Plug to Cable Mode.....	189
7-3-7 System Beep Volume	190
7-3-8 System Virbator	190
7-3-9 Setup Virbator.....	191
7-3-10 Header Str Sw	191
7-3-11 Header Serial Number	191
7-3-12 Header Date & Time	192
7-3-13 Header Record Count.....	192
7-3-14 Footer Str Sw.....	192
7-3-15 Footer Serial Number	193
7-3-16 Footer Date & Time.....	193
7-3-17 Footer Record Count	194
7-3-18 Lamp Light Brightness	194
7-3-19 DLE Escape Characters	195
7-3-20 CMD Escape Characters	195
7-3-21 BAR Escape Characters.....	196
7-3-22 ETX Escape Characters	196
7-3-23 STX Escape Characters	197
7-3-24 Date Separator	197
7-3-25 Time Separator	198
7-3-26 Wait Addon Count.....	198
7-3-27 Double Confirm Count	199
7-3-28 Continue Mode Clear Time	199
7-3-29 Setup Time	200
7-3-30 Set Date & Time Format	200
7-3-31 All Memory Data Clear.....	201
7-3-32 All Data Transmission	201
7-3-33 Footer Chatacters	201
7-3-34 Header Chatacters.....	202
Chapter 8: Symbology Settings.....	203
8-1 Barcode Symbologies Default Setting Chart	204

8-2 UPC-A	205
8-2-1 Read	205
8-2-2 Add-on Type	205
8-2-3 Wait Add-on	206
8-2-4 Truncate Leading Zeros	206
8-2-5 Transmission Checksum	207
8-2-6 Truncate Leading Characters	207
8-2-7 Truncate Trailing Characters	208
8-2-8 Position for Inserting	208
8-2-9 Position for Inserting Characters	209
8-2-10 Code ID for UPC-A	209
8-3 UPC-E	210
8-3-1 Read	210
8-3-2 Wait Add-on	210
8-3-3 Expansion	211
8-3-4 Add-On Type	211
8-3-5 Transmission Checksum	212
8-3-6 Truncate Leading Zeros	212
8-3-7 Truncate Leading Characters	213
8-3-8 Truncate Trailing Characters	213
8-3-9 Position for Inserting	214
8-3-10 Position for Inserting Characters	214
8-3-11 Code ID for UPC-E	215
8-3-12 Sub Code ID for UPC-E	215
8-4 EAN-13	216
8-4-1 Read	216
8-4-2 Wait Add-on	216
8-4-3 Add-on Type	217
8-4-4 ISBN/ISSN Conversion	217
8-4-5 Truncate Leading Zeros	218
8-4-6 Transmission Checksum	218
8-4-7 Truncate Leading Characters	219
8-4-8 Truncate Trailing Characters	219
8-4-9 Position for Inserting	220
8-4-10 Position for Inserting Characters	220
8-4-11 Code ID for EAN-13	221
8-4-12 Sub Code ID for EAN-13	221
8-5 EAN-8	222
8-5-1 Read	222
8-5-2 Wait Add-on	222

8-5-3 Add-on Type.....	223
8-5-4 Expansion.....	223
8-5-5 Transmission Checksum.....	224
8-5-6 Truncate Leading Zeros.....	224
8-5-7 Truncate Leading Characters.....	225
8-5-8 Truncate Trailing Characters.....	225
8-5-9 Position for Inserting.....	226
8-5-10 Position for Inserting Characters.....	226
8-5-11 Code ID for EAN-8.....	227
8-5-12 Sub Code ID for EAN-8.....	227
8-6 Code-39.....	228
8-6-1 Read.....	228
8-6-2 Type.....	228
8-6-3 Code 32 translation.....	229
8-6-4 Transmission Start/End.....	229
8-6-5 Checksum Verification.....	230
8-6-6 Transmission Checksum.....	230
8-6-7 Truncate Leading Zeros.....	230
8-6-8 Min/Max Code Length.....	231
8-6-9 Truncate Leading Characters.....	231
8-6-10 Truncate Trailing Characters.....	232
8-6-11 Position for Inserting.....	232
8-6-12 Position for Inserting Characters.....	233
8-6-13 Code ID for Code-39.....	233
8-6-14 Sub Code ID for Code-39.....	234
8-7 Codabar/NW7.....	235
8-7-1 Read.....	235
8-7-2 Start/ End Symbol Types.....	235
8-7-3 Same Start/End Pair.....	236
8-7-4 Transmission Start/End.....	236
8-7-5 Checksum Verification.....	237
8-7-6 Transmission Checksum.....	237
8-7-7 Truncate Leading Zeros.....	238
8-7-8 Min/Max Code Length.....	238
8-7-9 Truncate Leading Characters.....	239
8-7-10 Truncate Trailing Characters.....	239
8-7-11 Position for Inserting.....	240
8-7-12 Position for Inserting Characters.....	240
8-7-13 Code ID for Codabar/NW7.....	241
8-8 Code-128.....	242

8-8-1 Read	242
8-8-2 Type	242
8-8-3 Checksum Verificaiton	243
8-8-4 Transmission Checksum	243
8-8-5 Truncate Leading Zeros	243
8-8-6 ID Separtor UCC-128/GS1-128	244
8-8-7 Min/Max Code Length	244
8-8-8 Truncate Leading Characters	245
8-8-9 Truncate Trailing Characters	245
8-8-10 Position for Inserting	246
8-8-11 Position for Inserting Characters	246
8-8-12 Code ID for Code-128	247
8-8-13 Code ID for Code-128	247
8-9 Interleaved 2 of 5	248
8-9-1 Read	248
8-9-2 Checksum Verification	248
8-9-3 Transmission Checksum	249
8-9-4 Truncate Leading Zeros	249
8-9-5 Min/Max Code Length	250
8-9-6 Truncate Leading Characters	250
8-9-7 Truncate Trailing Characters	251
8-9-8 Position for Inserting	251
8-9-9 Position for Inserting Characters	252
8-9-10 Code ID for Interleaved 2 of 5	252
8-10 Industrial 2 of 5	253
8-10-1 Read	253
8-10-2 Checksum Verification	253
8-10-3 Transmission Checksum	254
8-10-4 Truncate Leading Zeros	254
8-10-5 Min/Max Code Length	255
8-10-6 Truncate Leading Characters	255
8-10-7 Truncate Trailing Characters	256
8-10-8 Position for Inserting	256
8-10-9 Position for Inserting Characters	257
8-10-10 Code ID for Industrial 2 of 5	257
8-11 Matrix 2 of 5	258
8-11-1 Read	258
8-11-2 Checksum Verification	258
8-11-3 Transmission Checksum	259
8-11-4 Truncate Leading Zeros	259

8-11-5 Min/Max Code Length.....	260
8-11-6 Truncate Leading Characters.....	260
8-11-7 Truncate Trailing Characters.....	261
8-11-8 Position for Inserting.....	261
8-11-9 Position for Inserting Characters.....	262
8-11-10 Code ID for Matrix 2 of 5.....	262
8-12 Code-93.....	263
8-12-1 Read.....	263
8-12-2 Transmission Checksum.....	263
8-12-3 Checksum Verification.....	264
8-12-4 Truncate Leading Zeros.....	264
8-12-5 Min/Max Code Length.....	265
8-12-6 Truncate Leading Characters.....	265
8-12-7 Truncate Trailing Characters.....	266
8-12-8 Position for Inserting.....	266
8-12-9 Position for Inserting Characters.....	267
8-12-10 Code ID for Code-93.....	267
8-13 Code-11.....	268
8-13-1 Read.....	268
8-13-2 Checksum Transmission.....	268
8-13-3 Verify Checksum.....	269
8-13-4 Truncate Leading Zeros.....	269
8-13-5 Min/Max Code Length.....	270
8-13-6 Truncate Leading Characters.....	270
8-13-7 Truncate Trailing Characters.....	271
8-13-8 Position for Inserting.....	271
8-13-9 Position for Inserting Characters.....	272
8-13-10 Code ID for Code-11.....	272
8-14 MSI/Plessey.....	273
8-14-1 Read.....	273
8-14-2 Transmission Checksum.....	273
8-14-3 Checksum Verification.....	274
8-14-4 Truncate Leading Zeros.....	275
8-14-5 Min/Max Code Length.....	275
8-14-6 Truncate Leading Characters.....	276
8-14-7 Truncate Trailing Characters.....	276
8-14-8 Position for Inserting.....	277
8-14-9 Position for Inserting Characters.....	277
8-14-10 Code ID for MSI/Plessey.....	278
8-15 UK/Plessey.....	279

8-15-1 Read	279
8-15-2 Verify Checksum.....	279
8-15-3 Transmission Checksum.....	280
8-15-4 Truncate Leading Zeros.....	280
8-15-5 Min/Max Code Length.....	281
8-15-6 Truncate Leading Characters.....	281
8-15-7 Truncate Trailing Characters.....	282
8-15-8 Position for Inserting	282
8-15-9 Position for Inserting Characters.....	283
8-15-10 Code ID for UK/Plessey.....	283
8-16 Telepen	284
8-16-1 Read	284
8-16-2 Checksum Verification	284
8-16-3 Type.....	285
8-16-4 Transmission Checksum.....	285
8-16-5 Truncate Leading Zeros.....	286
8-16-6 Min/Max Code Length.....	286
8-16-7 Truncate Leading Characters.....	287
8-16-8 Truncate Trailing Characters.....	287
8-16-9 Position for Inserting	288
8-16-10 Position for Inserting Characters.....	288
8-16-11 Code ID for Telepen	289
8-17 RSS(GS1 DataBar)14	290
8-17-1 Read	290
8-17-2 Code Mark	290
8-17-3 Application ID.....	291
8-17-4 Transmission Checksum.....	291
8-17-5 Truncate Leading Zeros.....	292
8-17-6 Truncate Leading Characters.....	292
8-17-7 Truncate Trailing Characters.....	293
8-17-8 Position for Inserting	293
8-17-9 Position for Inserting Characters.....	294
8-17-10 Code ID for RSS(GS1 DataBar)14	294
8-18 RSS(GS1 DataBar) Limited	295
8-18-1 Read	295
8-18-2 Code mark	295
8-18-3 Application ID.....	296
8-18-4 Transmission Checksum.....	296
8-18-5 Truncate Leading Zeros.....	297
8-18-6 Truncate Leading Characters.....	297

8-18-7 Truncate Trailing Characters	298
8-18-8 Position for Inserting	298
8-18-9 Position for Inserting Characters.....	299
8-18-10 Code ID for RSS(GS1 DataBar) Limited.....	299
8-19 RSS(GS1 DataBar)14 Stack.....	300
8-19-1 Read	300
8-19-2 Code Mark	300
8-19-3 Application ID.....	301
8-19-4 Transmission Checksum.....	301
8-19-5 Truncate Leading Zeros.....	302
8-19-6 Truncate Leading Characters.....	302
8-19-7 Truncate Trailing Characters.....	303
8-19-8 Position for Inserting	303
8-19-9 Position for Inserting Characters.....	304
8-19-10 Code ID for RSS(GS1 DataBar)14 Stack.....	304
8-20 RSS(GS1 DataBar) Expansion	305
8-20-1 Read	305
8-20-2 Code Mark	305
8-20-3 Application ID.....	306
8-20-4 Transmission Checksum.....	306
8-20-5 Truncate Leading Zeros.....	307
8-20-6 Truncate Leading Characters.....	307
8-20-7 Truncate Trailing Characters.....	308
8-20-8 Position for Inserting	308
8-20-9 Position for Inserting Characters.....	309
8-20-10 Code ID for RSS(GS1 DataBar) Expansion.....	309
8-21 RSS(GS1 DataBar) Expansion Stack.....	310
8-21-1 Read	310
8-21-2 Code Mark	310
8-21-3 Application ID.....	311
8-21-4 Transmission Checksum.....	311
8-21-5 Truncate Leading Zeros.....	312
8-21-6 Truncate Leading Characters.....	312
8-21-7 Truncate Trailing Characters.....	313
8-21-8 Position for Inserting	313
8-21-9 Position for Inserting Characters.....	314
8-21-10 Code ID for RSS(GS1 DataBar) Expansion.....	314
Hexadecimal / Decimal TABLE.....	315
ASCII Code Table	316

Chapter 1: important Notice

Important Notice:

1-1 Regulations

**1-2 TECHNICAL REGULATIONS CONFORMITY FOR SPECIFIED RADIO
EQUIPMENT IN JAPAN**

1-3 NATIONAL COMMUNICATION COMMISSION

1-4 RoHS DIRECTIVES

1-5 SAFETY PRECAUTION

1. Important Notice:

1-1 REGULATIONS

This device complies with part 15 of the FCC Rules. Operation is subject to the following two conditions: (1) This device may not cause harmful interference, and (2) this device must accept any interference received, including interference that may cause undesired operation.

This device has been tested and found to comply with the limits for a Class B digital device, pursuant to Part 15 of the FCC Rules. These limits are designed to provide reasonable protection against harmful interference in a residential installation. This equipment generates uses and can radiated radio frequency energy and, if not installed and used in accordance with the instructions, may cause harmful interference to radio communications. However, there is no guarantee that interference will not occur in a particular installation. If this equipment does cause harmful interference to radio or television reception, which can be determined by turning the equipment off and on, the user is encouraged to try to correct the interference by one or more of the following measures:

- Reorient or relocate the receiving antenna.
- Increase the separation between the equipment and receiver.
- Connect the equipment into an outlet on a circuit different from that to which the receiver is connected.

1-2 TECHNICAL REGULATIONS CONFORMITY FOR SPECIFIED RADIO EQUIPMENT IN JAPAN

Certificate Number: 204WW81000100



204WW81000100

1-3 NATIONAL COMMUNICATION COMMISSION**NCC Registration Number: NCC-RCB-05****Qualified serials number on device:****1-4 RoHS DIRECTIVE**

The RoHS directive (European Parliament Directive 2002/95/EC) mandates that producers of electrical or electronic equipment sold into Europe must minimize or eliminate the following materials from their design, as they are considered health risks:



1. Lead
2. Mercury
3. Cadmium
4. Hexavalent Chromium
5. Polybrominated biphenyls (PBB)
6. Polybrominated diphenyl ethers (PBDE)

These Materials must be reduced to their appropriate level (as announced by the directive) by July 1, 2006.

Technology committed to the environment, which makes the necessary changes to our products in order to comply with the directive. This involves converting most of the non-compliant components (electronics, PC boards, etc.) of our products to the compliant equivalent. We also changed the assembly processes (solder, glue, etc) to fully compliant with the directive. These changes will not affect the form, size or function of our products and the important thing is the reliability and performance remains the same.

1-5 SAFETY PRECAUTION

- Do not stare the scanning light source beam.
- Do not touch the device transparent window, reading performance might decrease if transparent window is dirty or scratch.
- Do not disassemble or modify the internal components from the scanner.
- Do not expose the scanner to any flammable source.
- Do not over charge the battery.

Lithium-Ion polymer Battery

- The Lithium-Ion polymer battery energy density is less than 400 Wh/L. Therefore, PSE certification does not required in this product.
- First time battery charge will take 4 hours for fully charge.
- Battery Life time:
 - Memory Mode: Approx. 18000 scans (5 sec/per scan).
 - Bluetooth Mode: Approx. 15000 scans (5 sec/ per scan).
- Do not assemble / disassemble the battery without technical support.
- Do not use unspecified power adaptor to charge the battery.
- During the charging process, if red color LED indicator flashing rapidly, discontinued the charging process, and return the scanner to the authorized dealer.
- Any leakage of fluid or abnormal odor occurred, discontinued the operation of the scanner, and returns to authorized dealer.
- Any leakage of fluid from the battery, avoid any contact with skins or eyes, if situation occurred, rinse with fresh water and consult the doctor immediately.

Chapter 2: Introduction

Introduction:

2-1 PRODUCT FEATURES

2-2 PRODUCT SPECIFICATION

2-3 PACKAGE INFORMATION

2-4 DEFAULT SYMBOLOGIES

2-5 FUNCTION KEYS AND LED INDICATOR

2-6 QUICK START GUIDE

2. Introduction

2-1 PRODUCT FEATURES

- Ergonomic and lightweight
- Three in one functions (Bluetooth/ Memory/ Cabled)
- USB cable can be used as cabled scanner, data transferring from flash memory, and battery charging cable.
- Six different Bluetooth mode (Master, Slave, USB HID, iPad mode, A-303 Dongle and A-302 Dongle) to communicate between PC, mobile phone , PDA ,A-303 Dongle and A-302 Dongle.
- Programmable time stamp and output data format
- Programmable Beep tone, volume.
- Flash memory can stored up to 130000 barcode data with time stamp (bas-on EAN-13 barcode symbology)

2-2 PRODUCT SPECIFICATION

Model No.	CM-520W wireless series	
Microprocessor	32 bits CPU	
Main battery operation times	8000 scans in Bluetooth Mode (5 sec /per scan)	
Supported barcodes	Code 39, INT 25, Industrial 2 of 5, Matrix 2 of 5, Codabar(NW7), Code 93, Code 128,EAN 128, JAN/EAN/ UPC and fully RSS code (GS1 Databar)	
Min. PCS value	0.45	
Scan Engine	CCD Type	630nm Red LED LAMP, Linear CCD Image Sensor Scan rate : 100 scan/sec, Scan distance : 50mm~250mm
	Laser Type	Visible Laser Diode 650nm ± 10 (25 $^{\circ}$ C) Scan rate : 100 scan/sec Scan distance : 50mm~350mm
Main battery	Built in Rechargeable Li-polymer battery pack.,(3.7V, 420mAH) charging via USB port	
Wireless Communication	2.4Ghz Bluetooth Class I	
Keys	2 keys, 1 for scan 1 for clear data.	
LED indicator	1 LED 2 colors (green and orange) for Memory mode 1 LED (red) for low battery 1 LED(blue) for wireless communication on-line status	
Beep indicator	Buzzer can be disable or enable by configuration	
Temperature in operation	-10 ~ +40 $^{\circ}$ C	
Environment Humidity	10%-90%RH	
Certification	FCC / CE / RoHS approved, VCCI, Telec	
Operation system	Windows XP/2000/Vista/Win 7, Win8	
Dimension	(L x W x H) 89 x 40 x 17.5 mm	
Weight	CCD : 75g / Laser : 85g	
Power consumption	CCD : 90mA / Laser : 60mA	

2-3 PACKAGE INFORMATION

The package included: Scanner, Bluetooth Dongle (optional), power adaptor (optional), Lanyard, USB cable, Quick start guide, product CD.

Note: The product CD includes: Quick start guide, user manual, Bluetooth setting software, barcode scanner setting software.

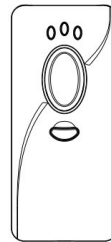
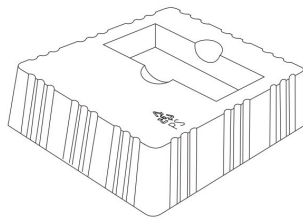
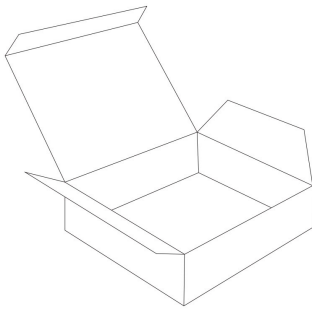

(Optional)

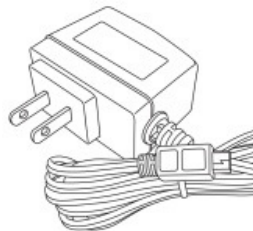
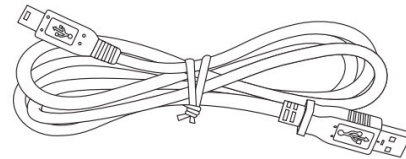
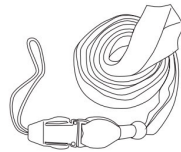
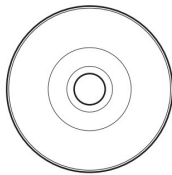

(Optional)

2-4 DEFAULT SYMBOLOGIES

Symbologies		Default setting
EAN/ UPC	UPC-A	Enabled
	UPC-E	Enabled
	EAN-8	Enabled
	EAN-13	Enabled
	EAN-13(ISBN)	Disabled
Code 39		Enabled
Interleaved 2/5		Disabled
Industrial 2/5		Disabled
Matrix 2/5		Disabled
Codabar/ NW7		Enabled
Code 128		Enabled
Code 93		Disabled
Code 11		Disabled
MSI/ Plessey		Disabled
UK/ Plessey		Disabled
Telepen		Disabled
GS1 Databar (RSS)	RSS14	Disabled
	RSS14 Limited	Disabled
	RSS 14 Stacked	Disabled
	RSS Expansion	Disabled
	RSS Expansion Stacked	Disabled

2-5 FUNCTION KEYS AND LED INDICATOR

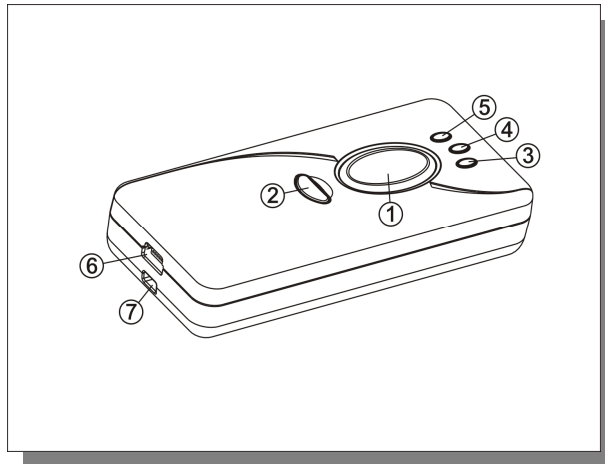

- ① Press down **Scan Button** to decode or store the barcode.
- ② Press down **Small Trigger** to perform versatile supplementary functions. For instance, pressing the key will lead to erasing barcode data which have been previously decoded in Memory Mode; it also works to pair the scanner with the Bluetooth devices in Bluetooth Mode.
- ③ **Power Indicator** indicates the charge status. When the battery is running low, red LED light will be on to show a poor charge level. Once the charging process is completed, red LED will flash slowly to show a full battery charge.
- ④ **Good Read Indicator** indicates whether the barcode is successfully decoded. Green LED shows a successful decoding attempt.
- ⑤ **Mode Indicator** indicates the current operation mode. Blue LED stands for Bluetooth mode, green LED for Cable mode, and orange LED for Memory mode.
- ⑥ **Strap Hole**
- ⑦ Secure the interface cable into **USB Host** in an attempt to transmit data or to charge the battery.
- ⑧ Replace the battery in the **Battery Compartment**.

2-6 QUICK START GUIDE

The Quick Start guide demonstrates how to connect the scanner with Bluetooth Dongle, and some of the quick references. For detail configuration with Bluetooth, please refer to related chapter.

How to connect the scanner with Bluetooth Dongle

Procedure

Step 1 >

Insert Bluetooth Dongle to USB port.

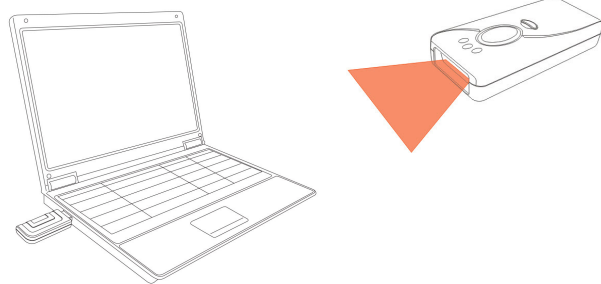

Step 2 >

Make sure the scanner is in Bluetooth mode. If scanner is in memory mode, press and hold the scan key for few seconds until beep sound and orange LED light indication OR scan the mode switching barcode.

Step 3>

When the scanner is in Bluetooth mode, press the scan key again and wait for few seconds, the Bluetooth connection will automatically establish. If connection successful, the Blue LED indicator will be on.

Step 4>

When Bluetooth Connection established, execute any word processing software, for example: Word, notepad, Excel and etc. to receive to barcode data.

Note: Bluetooth connection will switch to sleep mode if not in use; Press Scan OR erase key once will reestablish the Bluetooth connection.

Scanner Operation Guide

Operation Mode

When plug in the USB cable with scanner.

- It will start with short melody and the red LED will be indicated.
- Execute Word, Excel or any word processing software; scan the barcode will transmit the barcode data to the word processing software in real time.
- When the barcode is successfully read, beep sound and green LED will be indicated.

Note: after uploading the barcode data to PC, the barcode data in the memory will not be erase. User needs to erase the barcode data manually.

When Unplug the USB cable with scanner.

- It will automatically switch to Memory mode / Bluetooth mode.
- Press the erase key and point to the scanned barcode label, this action will erase the previously saved barcode data in the memory scanner.

Transmitting barcode data



(Send)

Send barcode data by Bluetooth OR connected by USB cable.

Clear all saved barcode data



(Clear)

Clear all barcode data in the memory

Warning: Scan the "Clear" barcode will lose all the barcode data.

Important Note: For better Bluetooth transmission quality, when holding the scanner, please avoid covering the reverse top cover.



Chapter 3: Scanner Configuration

Scanner Configuration Quick Start

3-1 CONFIGURATION BY USER MANUAL

3-2 CONFIGURATION BY SOFTWARE

3. Scanner Configuration Quick Start

3-1 CONFIGURATION BY USER MANUAL

In the user manual, print out the related topics of setting page, simply use the scanner to scan the barcode for configuration.

For example:

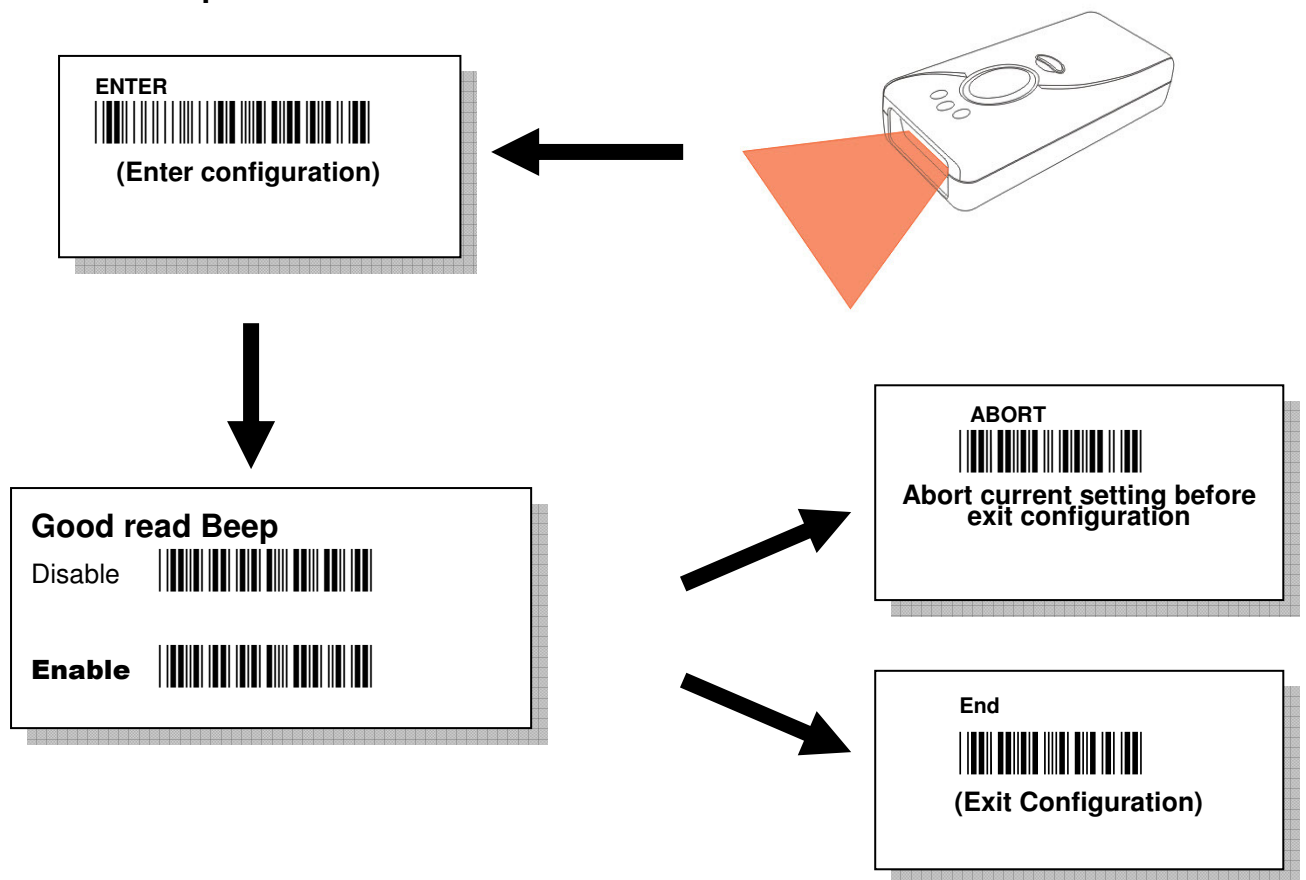

Factory Default setting: user may configure the scanner back to all default settings, if configuration goes wrong.

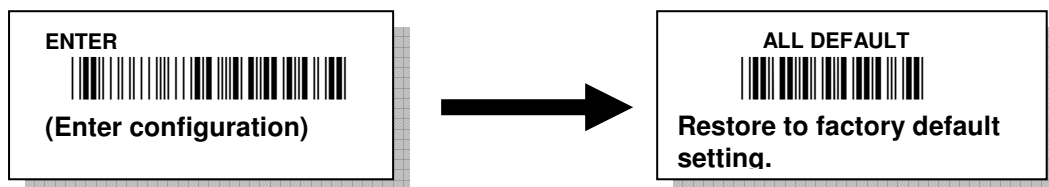

3-2 CONFIGURATION BY SOFTWARE

In the product CD, you can find configuration software “Normal command setting” to configure the parameters.

Scanner general settings: (CM-520\Software\Normal command setting\Scanner Setting.exe)

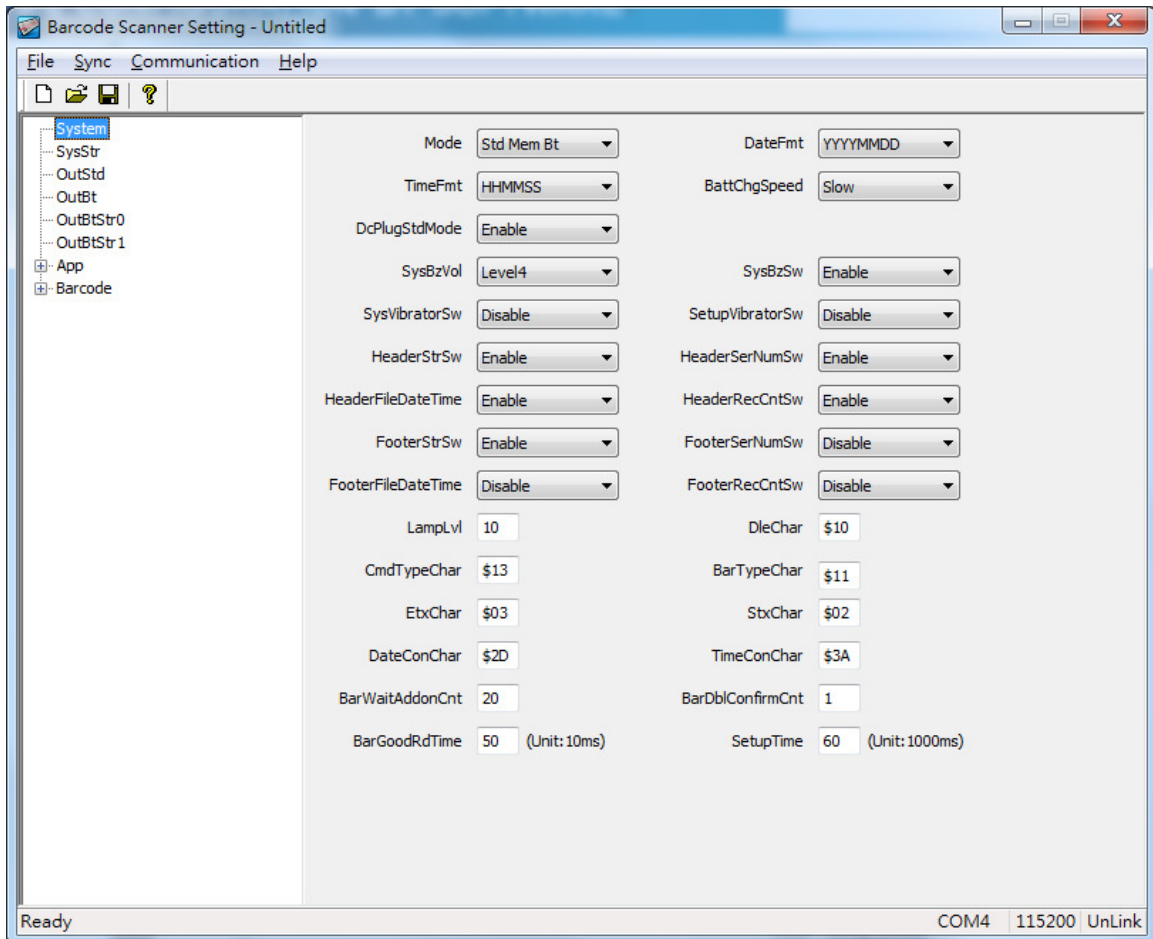

Note: Please refer to the related configuration chapters or additional manual for how to use the software.

Chapter 4: Memory / Bluetooth Mode**Memory / Bluetooth Mode:****4-1 Memory Mode****4-1-1 Function Switch (Bluetooth mode to Memory mode)****4-1-2 Transmitting barcode data in memory mode****4-1-3 Erase barcode data (single data/ all data) in memory mode****4-2 Bluetooth Mode****4-2-1 Function switch (Memory Mode to Bluetooth mode)****4-2-2 Bluetooth Mode LED indication****4-2-3 Bluetooth mode selection Code Table****4-2-4 Bluetooth mode configuration by user manual****4-2-4-1 Slave Mode-Third party Bluetooth devices (Mode selection code:1)****4-2-4-2 Master Mode -Third party Bluetooth devices (Mode selection code: 2)****4-2-4-3 HID Mode - For third party Bluetooth devices (Mode selection code: 3)****4-2-4-4 iOS MODE (Mode selection code : 4)****4-2-4-5 A-303 dongle MODE (Mode selection code : 5)****4-2-4-6 A-302 dongle Mode (Mode selection code:6)****4-2-5 Bluetooth parameter configuration by user manual****4-2-5-1 BT Local name****4-2-5-2 Remote Mac Address****4-2-5-3 Pin Code**

4. Memory / Bluetooth Mode Explanation

This chapter explains the different functions between Memory function and Bluetooth function.

Note: If user only purchase Memory scanner model, switching to Bluetooth mode is not applicable.

4-1 Memory Mode

4-1-1 Function switch (Bluetooth mode to Memory mode)

There are two methods of switching from Bluetooth mode to Memory mode:

- 1) Long keep holding Scan key, till the LED as solid color, then release Scan key, will into the mode switching, if the LED turn to orange color, it is in Memory mode.

OR

- 2) Scan the following barcode to switch from Bluetooth Mode to Memory Mode.

(1) Enter: (Enter setting)



(2) To Memory mode

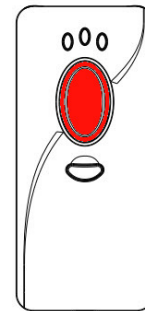

4-1-2 Transmitting barcode data in memory mode

There are two methods of sending the barcode data from barcode scanner.

- 1) **Connect the USB cable** between scanner and PC, keep holding Small Trigger till the LED as solid color, then release Small Trigger to into Transmit mode; at this moment, push Scan key will transmit the stored barcode data to your word processing software,

e.g. Word, excel, or notepad.

OR

- 2) Connect the USB cable between scanner and PC, and scan the below "Send" barcode.

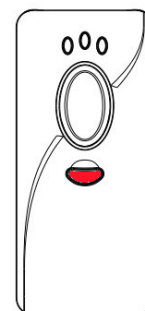



(Send)

4-1-3 Erase barcode data (Single data / ALL data)

Erase single data:

While holding Small Trigger and point to the scanned barcode, this action will erase the last previous saved barcode data in the memory.

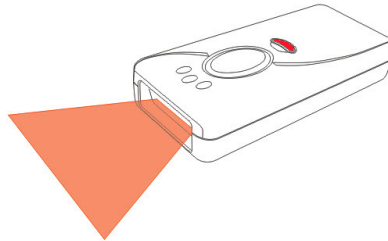

Erase all data:

1. While holding Small Trigger till Orange LED turns rapidly blinking,
2. Press down Scan Button
3. Release Scan Button and Small Trigger together, all barcode data saved in the memory will be erased.

OR

By scanning the send barcode as below:



(Clear)

Clear all barcode data in the memory

Caution: Scan the “Clear” Barcode will erase all the barcode data saved in the memory; make sure you have back up all the barcode data before performing this action.

4-2 Bluetooth Mode

User can configure different Bluetooth connection mode in different Bluetooth environment.

1. **Slave Mode** (For third party Bluetooth devices)
2. **Master Mode** (For third party Bluetooth devices)
3. **HID Mode** (Third party Bluetooth devices with USB HID mode only)
4. **iPAD/ iPhone OS Mode** (iPad, iPhone)
5. **A-303 Dongle Mode** (Original factory dongle, USB-HID / USB-COM configurable)
6. **A-302 Dongle Mode** (Original factory dongle , USB-HID only)
7. **Spp-A303PT Mode**(Original factory dongle, USB-COM Only)

4-2-1 Function switch (Memory Mode to Bluetooth mode)

There are two methods of switching from Memory mode to Bluetooth Mode:

- 1) Long keep holding Scan key, till the LED as solid color, then release Scan key, it will into the mode switching, if the LED turn to blue color, it is in BT mode.

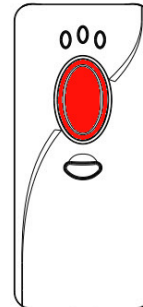

OR

1. Scan the following barcode to Bluetooth Mode.

(1) Enter: (Enter setting)



(2) To Bluetooth mode



4-2-2 LED indication under Bluetooth Mode

	Description
Red	indicates the charge status. When the battery is running low, red LED light will be on to show a poor charge level. Once the charging process is completed, red LED will flash slowly to show a full battery charge.
Green	Green:Good Read Indicator indicates whether the barcode is successfully decoded. Green LED shows a successful decoding attempt.
Blue	Under Bluetooth mode, and Bluetooth connection is not yet connected, the blue LED indicator will be flash per 3 seconds.
	Under Bluetooth Mode and if Bluetooth connection is not connected, Press and Hold the delete key until BLUE LED indicator flashing rapidly, at this time, release the delete key after Press Scan key for Bluetooth pairing with your device.
	When power on and if Bluetooth is connected, the blue LED will be on.

4-2-3 Bluetooth mode selection Code Table

Bluetooth mode selection code Table		
Mode	Description	Mode selection Code
Slave Mode	Applied to third party Bluetooth dongle, or build-in Bluetooth devices	1
Master Mode	Applied to third party Bluetooth dongle, or build-in Bluetooth devices	2
HID Mode	Third party Bluetooth dongle, or build in Bluetooth device with USB HID mode only	3
iOS Mode	iPad, iPhone devices	4
A-303 Dongle Mode	Applied to original factory dongle, USB-HID / USB-COM configurable	5
A-302 Dongle Mode	Original factory dongle , USB-HID only	6
Spp-A303PT Mode	Original factory dongle, USB-COM Only	7

4-2-4 Bluetooth mode configuration by user manual

4-2-4-1 Slave Mode : Third party Bluetooth devices (Mode selection code:**1)**

This mode is for user to configure with third party Bluetooth dongle, or build-in Bluetooth device.

For slave mode configuration; please scan below barcodes step by step.

Procedure:

(1) Enter: (Enter setting)



(2) Mode: (selection Spp-Slave)



(3) End (Exit setting)

**4-2-4-2 Master Mode - Third party Bluetooth devices (Mode selection code: 2)**

This mode is for user to configure with third party Bluetooth dongle, or build-in Bluetooth device.

For master mode configuration, please scan below barcodes step by step.

Procedure:

(1)Enter: (Enter setting)



(2)Mode: (selection Spp-Master)



(3)End: (Exit setting)



4-2-4-3 HID Mode - For third party Bluetooth devices (Mode selection code: 3)

This mode is for user to configure with third party Bluetooth dongle, or build-in Bluetooth device with USB HID only.



For HID mode Configuration, please scan below barcodes step by step.

Procedure:	
(1)Enter: (Enter setting)	
(2)Mode: (selection Hid)	
(3)End: (Exit setting)	

4-2-4-4 Hid-iOS Mode (Mode selection code : 4)

This mode is for user to configure with iPad or iPhone devices

For Hid-iOS mode configuration, please scan below barcodes step by step.

Procedure:	
(1)Enter: (Enter setting)	
(2)Mode: (selection Hid-iOS)	
(3)End: (Exit setting)	

4-2-4-5 A-303 dongle Mode (Mode selection code: 5)

This mode is for user to configure with purchased original factory dongle, and it is **USB-HID / USB-COM configurable**.



For A-303 Dongle mode configuration, please scan below barcodes step by step.

Procedure:	
(1)Enter: (Enter setting)	
(2)Mode: (selection Hid-A303)	
(3)End: (Exit setting)	

4-2-4-6 A302 dongle Mode (Mode selection code:6)

This mode is for user to configure with purchased original factory dongle, but it **only support USB-HID**.

A-302 Dongle mode, please scan below barcodes step by step.

Procedure:	
(1)Enter: (Enter setting)	
(2)Mode: (selection Hid-A302)	
(3)End: (Exit setting)	

4-2-4-7 Spp-A303PT Mode (Mode selection code:7)

This mode is for user to configure with purchased original factory dongle, but it **only support USB-COM**.

Spp-A303PT mode, please scan below barcodes step by step.

Procedure:

(1)Enter: (Enter setting)



(2)Mode: (selection Spp-A303PT)



(3)End: (Exit setting)



4-2-5 Bluetooth parameter configuration by manual

4-2-5-1 BT Local name

1. Slave, Master, HID Dongle, Hid-iOS Device

This option enables to assign Bluetooth the scanner name. Please refer to the HEX ASCII table (Form 0~9, A~F). The first digit and last digit cannot be space or "-". If scanner name setting is incorrect, connection failure will occur.

Configuration	Max. Configurable Length	Default Setting
Please refer to ASCII table	16 digits	'Serial Adaptor'

Procedure:

(1) Enter: (Enter setting)



(2) "BtDevName"



(3) Scan Hexadecimal/Decimal Barcode table for input parameters.

(4) OK : (Selection confirmed)



(5) End: (Exit setting)

**Example:****Set Local name as 'BT Scanner'**

(A) Scan "Enter" barcode

(B) Scan "BtDevName" barcode

(C) Scan parameters from Hexadecimal / Decimal barcode table =>"4","2",

"5","4", "2","0", "5","3", "6","3", "6","1", "6","E", "6","E", "6","5", "7","2","OK"

(configured as 'BT Scanner', Please refer to ASCII TABLE)

(D) Scan "End" Barcode

2. A-303,A-302 Dongle,Spp-A303 PT

This option enables to assign Bluetooth the scanner name. Please refer to the HEX ASCII table (Form 0~9, A~F). The first digit and last digit cannot be space or "-". If scanner name setting is incorrect, connection failure will occur.

Configuration	Max. Configurable Length	Default Setting
Please refer to ASCII table	16 digits	'Serial Adaptor'

Procedure:

(1) Enter: (Enter setting)



(2) "DongleBtDevName"



(3) Scan Hexadecimal/Decimal Barcode table for input parameters.

(4) OK : (Selection confirmed)



(5) End: (Exit setting)

**Example:****Set Local name as 'BT Scanner'**

(A) Scan "Enter" barcode

(B) Scan "DongleBtDevName" barcode

(C) Scan parameters from Hexadecimal / Decimal barcode table =>"4","2",
"5","4", "2","0", "5","3", "6","3", "6","1", "6","E", "6","E", "6","5", "7","2","OK"
(configured as 'BT Scanner', Please refer to ASCII TABLE)

(D) Scan "End" Barcode





4-2-5-2 Remote Mac Address.

1. Slave, Master, HID Dongle, His-iOS Device

Mac address configuration, total of 12 digits, Please refer to the HEX ASCII table (From 0~9, A~F).

Configuration	Max. Configurable Length	Default Setting
Hexadecimal / decimal barcode table	12 digits	000000000000

Procedure:

- (1) Enter: (Enter setting) 
- (2) "BtMacAddr" 
- (3) Scan Hexadecimal/Decimal Barcode table for input parameters.
- (4) OK : (Selection confirmed) 
- (5) End: (Exit setting) 

Example:**Set Remote Mac Address to 00126F006EAA**

- A. Scan "Enter" barcode
- B. Scan "BtMacAddr" barcode
- C. Scan parameters from Hexadecimal /decimal barcode table =>"0", "0", "1", "2", "6", "F", "0", "0", "6", "E", "A", "A" → "OK" (Set "Remote Mac Address" value to **00126F006EAA**)
- D. Scan "End" barcode

Note:





If scanner connection mode is "Slave" or "HID" or "Hid-iOS" Mode, Mac Address configuration does not required.

2. A-303 , A302 Dongle ,Spp-A303PT

Mac address configuration, total of 12 digits, Please refer to the HEX ASCII table (From 0~9, A~F).

Configuration	Max. Configurable Length	Default Setting
Hexadecimal / decimal barcode table	12 digits	000000000000

Procedure:

- (1) Enter: (Enter setting) 
- (2) "DongleBtMacAddr" 
- (3) Scan Hexadecimal/Decimal Barcode table for input parameters.
- (4) OK : (Selection confirmed) 
- (5) End: (Exit setting) 

Example:**Set Remote Mac Address to 00126F006EAA**

- Scan "Enter" barcode
- Scan "DongleBtMacAddr" barcode
- Scan parameters from Hexadecimal /decimal barcode table =>"0", "0", "1", "2", "6", "F", "0", "0", "6", "E", "A", "A" → "OK" (Set "Remote Mac Address" value to **00126F006EAA**)
- Scan "End" barcode

Note:

If scanner connection mode is "A-303 Dongle" or "A-302 Dongle" or "Spp-A303PT" mode, configuration of Mac address does required, and the configuration cannot be "000000000000"

4-2-5-3 Pin Code

When the scanner and Bluetooth device is in the pairing process, user will need to enter the pin code for pairing confirmation. This pin code might be generate by Bluetooth devices or preconfigured by user depends on different mode setting.





(1) Under “Slave” or “Master” mode, pin code configuration is needed when the pairing action is performed.

(2) Under “A-303 Dongle” or “A-302 Dongle” mode, Pin code does not required.

(3) Under “HID” or “HID-iOS” Mode, during pairing process, the PC or other devices will generate the pin code, user will need to referred to that pin code, and scan the pin code digits from Hexadecimal / Decimal table.

Configuration Range	Max. Configurable Length	Default Setting
0000 ~ 9999	4 digits	1234

Procedure:

- (1) BT Module Enter: (Enter Bluetooth setting) 
- (2) “ BtPinCode” 
- (3) Scan Hexadecimal/Decimal Barcode table for input digits.
- (4) OK : (Selection confirmed) 
- (5) End: (Exit setting) 

Example:**Set Pin Code to 5678**

- (A) Scan “Enter” Barcode
- (B) Scan “BtPinCode” Barcode
- (C) Scan parameters from Hexadecimal/Decimal table =>“5”, “6”, “7”, “8”
→”OK”
(Set “Pin Code “ value to 5678)
- (D) Scan “End” Barcode

Bluetooth Mode – Bluetooth Connection Mode Instruction

5-1 Slave mode Connection (For Third party Bluetooth devices)

5-2 Master mode Connection (For third party Bluetooth Devices)

5-3 HID Mode Connection (For Third party Bluetooth devices)

5-4 HID iOS MODE Connection

5-5 A-303 Dongle Mode Connection (USB-HID / USB COM)

5-3-1 HID MODE:

5-3-2 USB-COM mode

5-6 A-302 Dongle Mode Connection (USB-HID only)

5-7 Spp-A303 PT Mode Connection(USB-COM only)

5. Bluetooth Connection Mode Instruction

5-1 Slave mode Connection (For Third party Bluetooth devices)

- **Make sure the scanner is in Bluetooth mode; please refer to chapter 4-2-1 for how to configure in Bluetooth mode.**
- **Make sure the Mode selection code is configured as “1”. Please refer to chapter 4-2-4-1.**

1. After connect with Dongle and PC, you will see Bluetooth sign in system display. Click right button of the mouse on this sign, and choose "Add a Device". See the screen below:

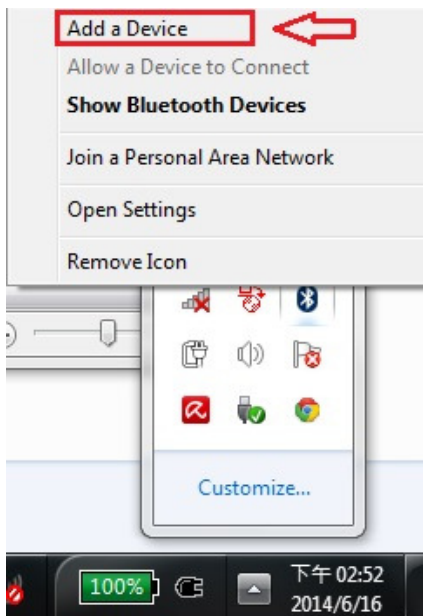

After choose this function, it will start to search a nearby Bluetooth device.

2. Make the scanner into pairing mode, if it can search available connecting Bluetooth device, it will show the screen below:

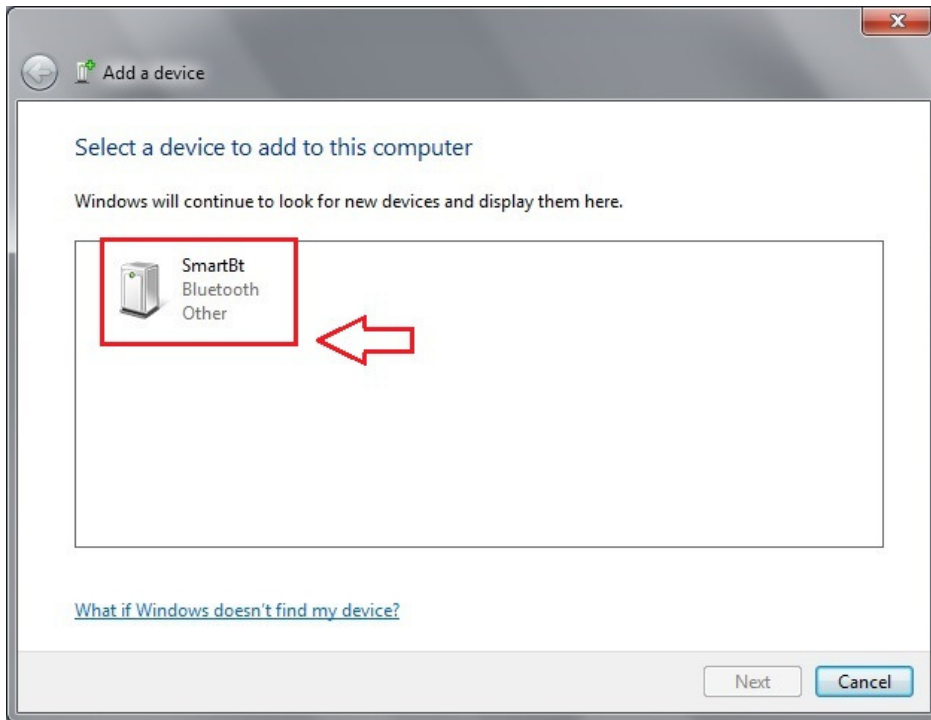

From all the finding devices, search the pairing Bluetooth device and click the left button of the mouse on finding devices. The popping out screen let users set Pin code by which way. See the screen below:

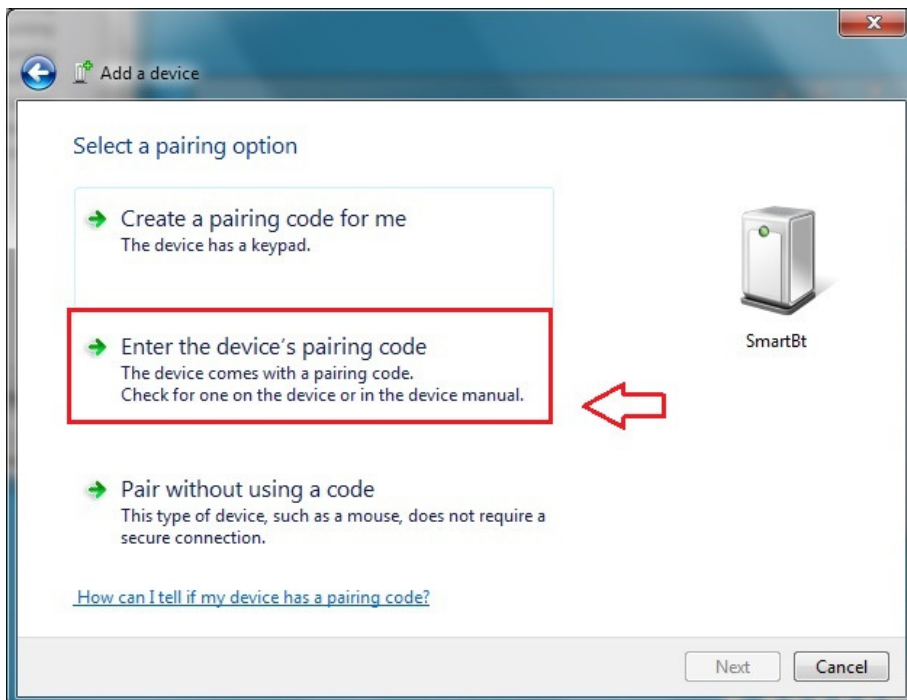

In this screen, choose "Enter the device's pairing code" will show up the screen below:

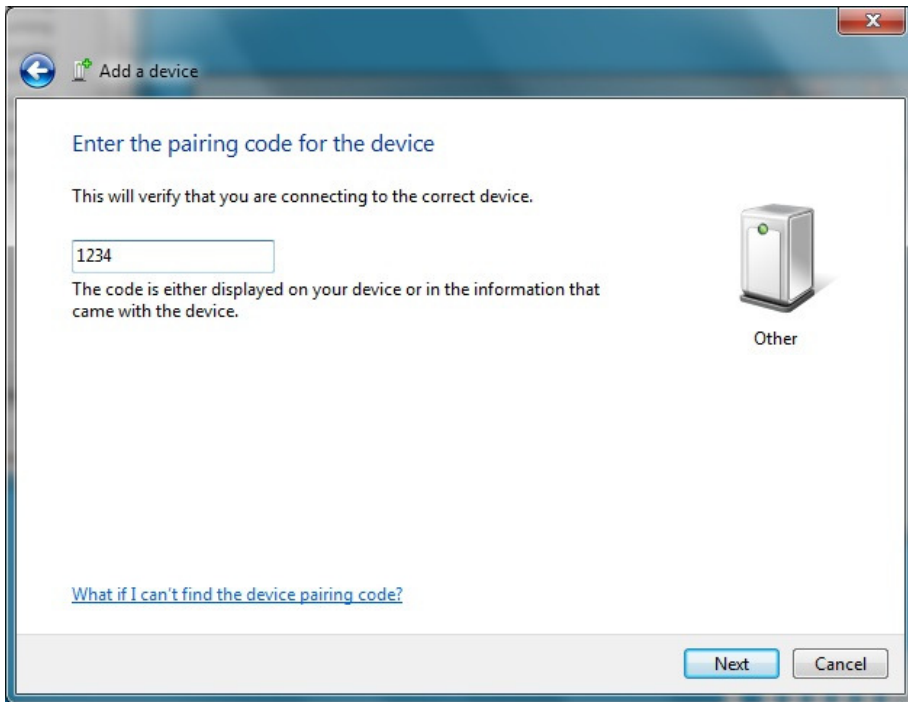

Please key in Pin Code with 1234 in this screen. After key in Pin code, press "Next" then it will start to do verification of Pin code. After pass the verification, it will go to pairing mode. After it pairs successfully, the screen will show like down below:

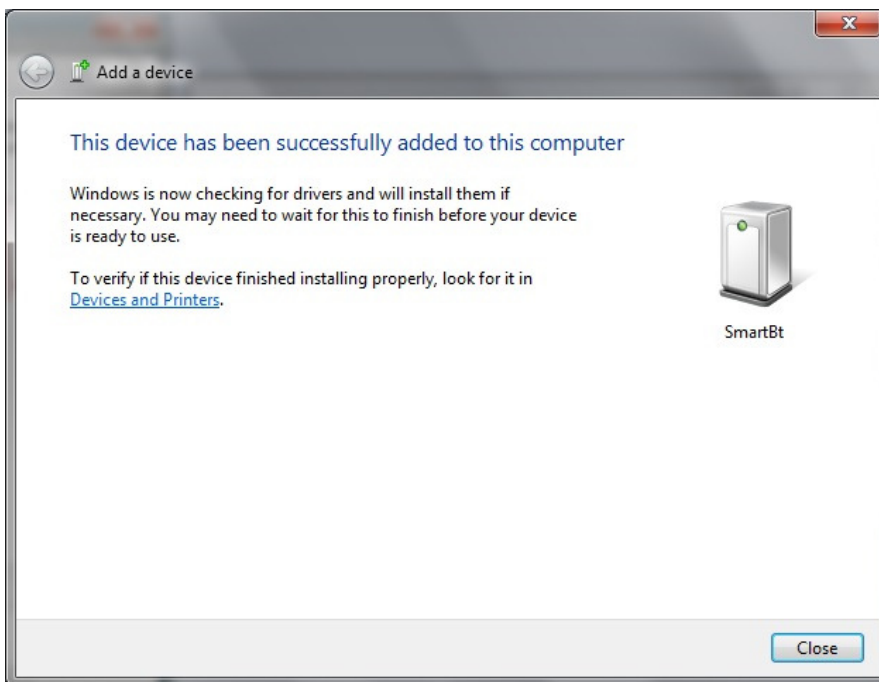

2. After it pairs successfully, click the right button of the mouse on Bluetooth sign in the system display. It will show screen below:

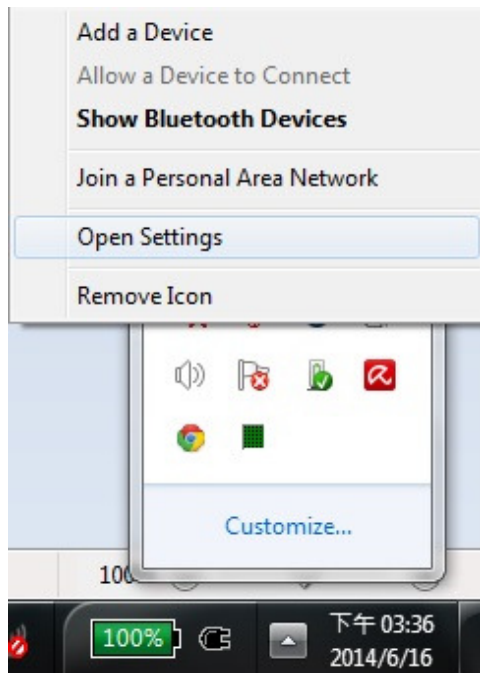

Choose "Open Settings" function and switch to the page of "COM Ports." It will show screen below:

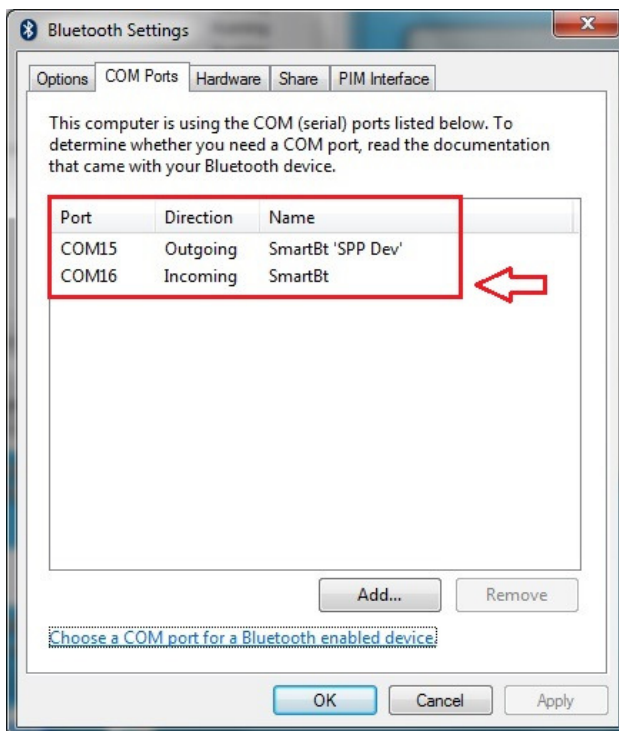

From this screen can know the current using COM Port of Bluetooth device. Due to the Bluetooth connection mode, it should choose "COM15" as using COM Port.

3. Turn on terminal software, and set COM Port as "COM15". It will show screen below:

5. Bluetooth Connection Mode Instruction

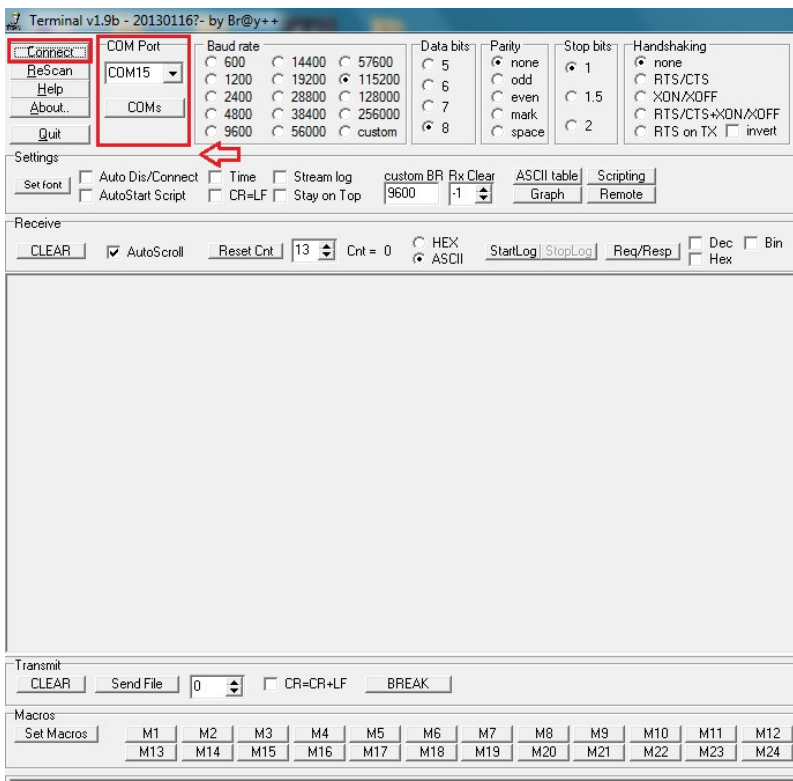

After select COM port, click "Connect" button to connect. After connect successfully, it can start to scan barcode, and scan result will show in terminal screen. It will show screen below:

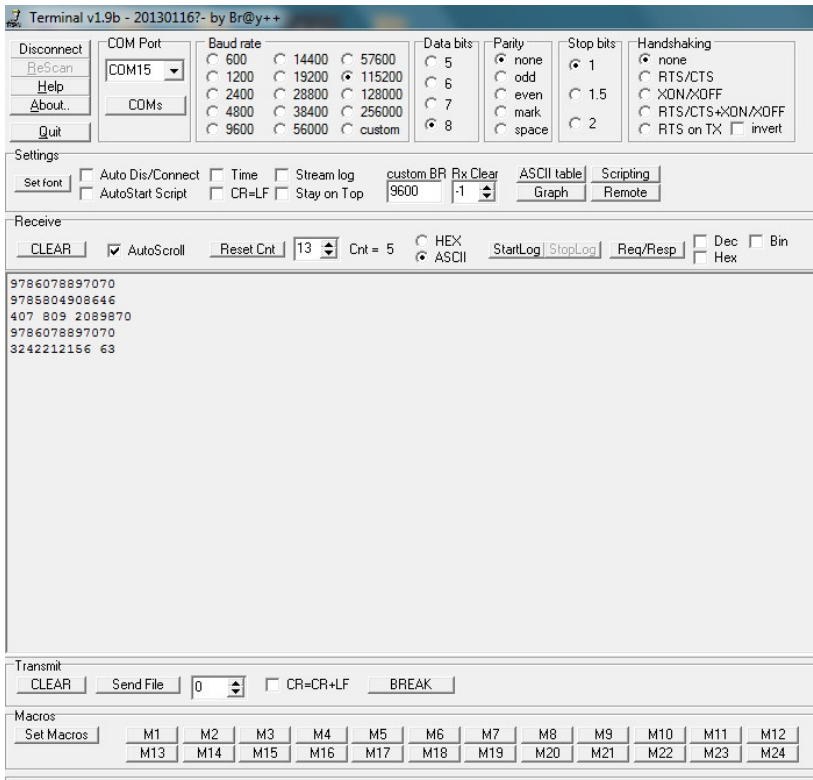

5-2 Master mode Connection (For third party Bluetooth Devices)

- **Make sure the scanner is in Bluetooth mode; please refer to chapter 4-2-1 for how to configure in Bluetooth mode.**
 - **Make sure the Mode selection code is configured as “2”. Please refer to chapter 4-2-4-2.**
4. After connect Dongle and PC, it will see Bluetooth sign in system display, and click right button of mouse on it. It will show screen below:

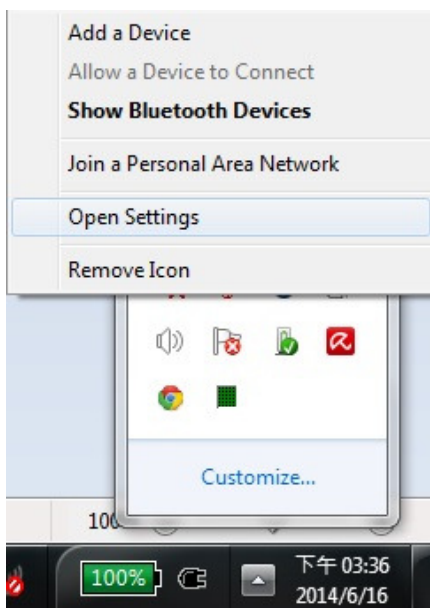

Choose "Open Settings" function, switch "Open Settings" function and switch to "Options" page.

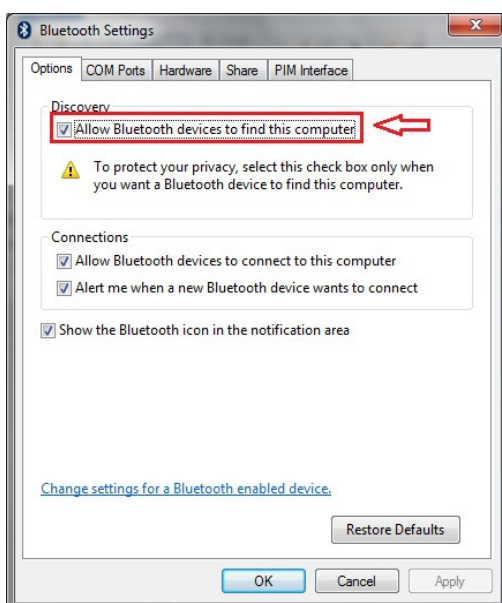

In this page, click "Allow Bluetooth devices to find this computer" to let this Bluetooth device can be searched.

5. Switch to "COM ports" page. It will show screen below:



6. In this page, click "Add" button to create new COM port. It will show screen below:

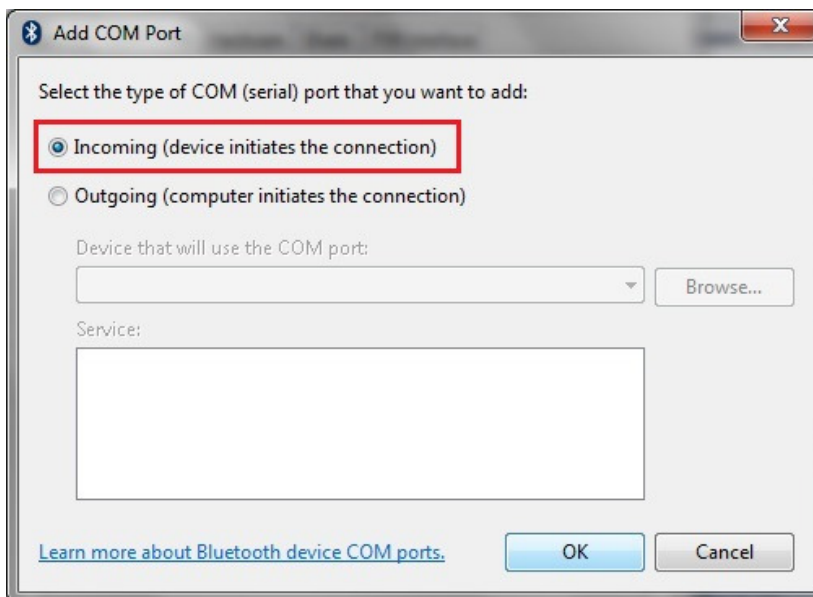

7. In this screen, click "Incoming(device initiates the connection)", and click"OK".In 此 the meantime, it will create Incoming port(COM14). It will show screen below:

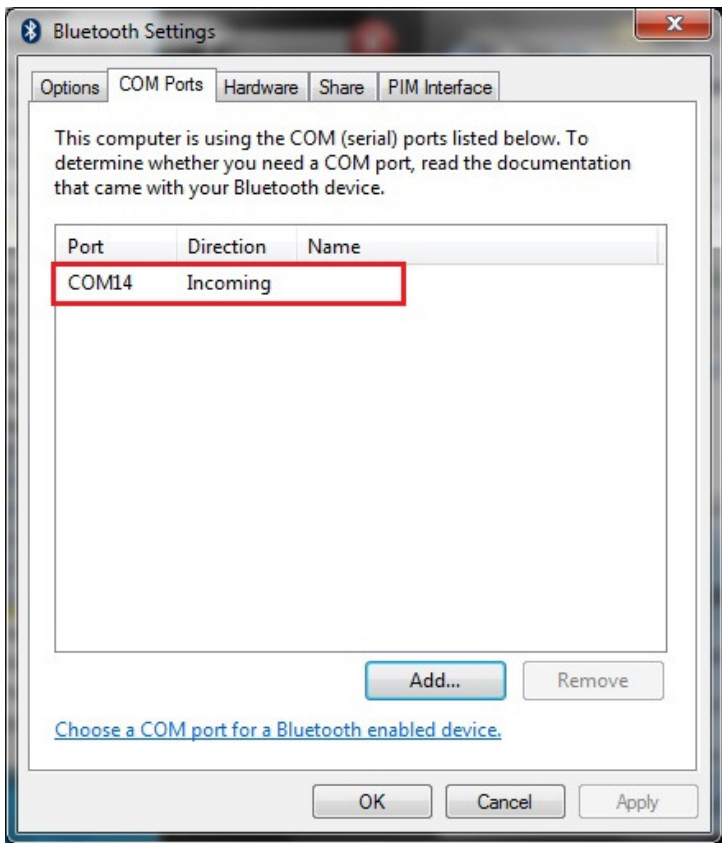

Click "OK" to finish setting.

- 8. Turn on terminal software, set COM Port as "COM14", and click "Connect" to start connect with this COM Port. It will show screen below:

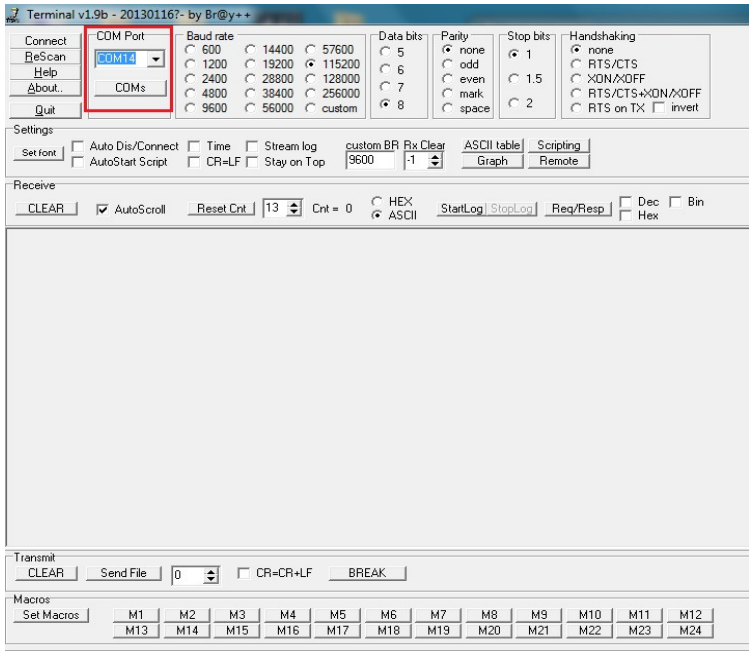

Make the scanner into pairing mode. When the scanner find the PC, it will show the information in system display to let user key Pin Code. It will show screen below:



Click this information and it will show screen below to let user to key Pin Code.

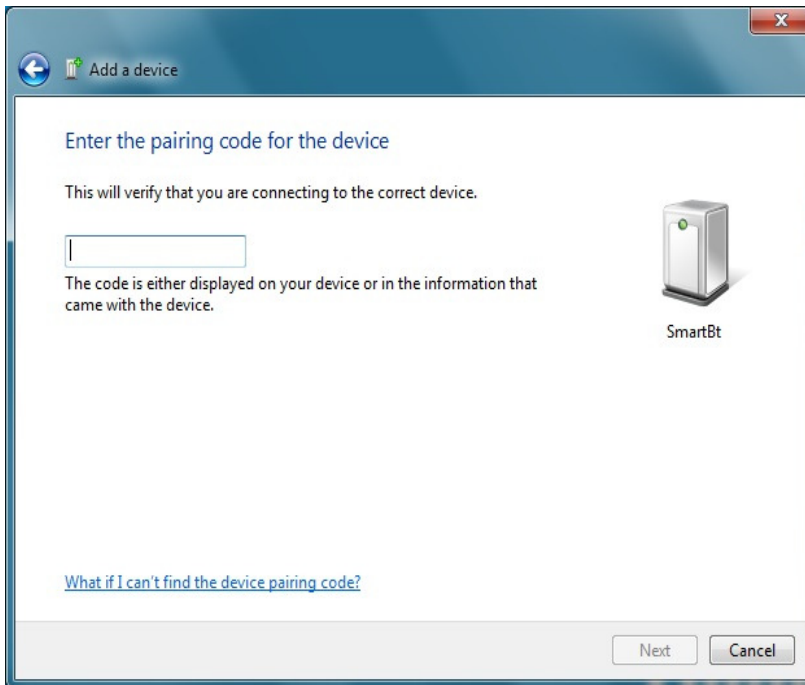

9. In this time, it can start to scan barcode, scanned result will show up in the terminal screen. It will show screen below:



10. In this time, it can start to scan barcode, scanned result will show up in the terminal screen. It will show screen below:

5. Bluetooth Connection Mode Instruction

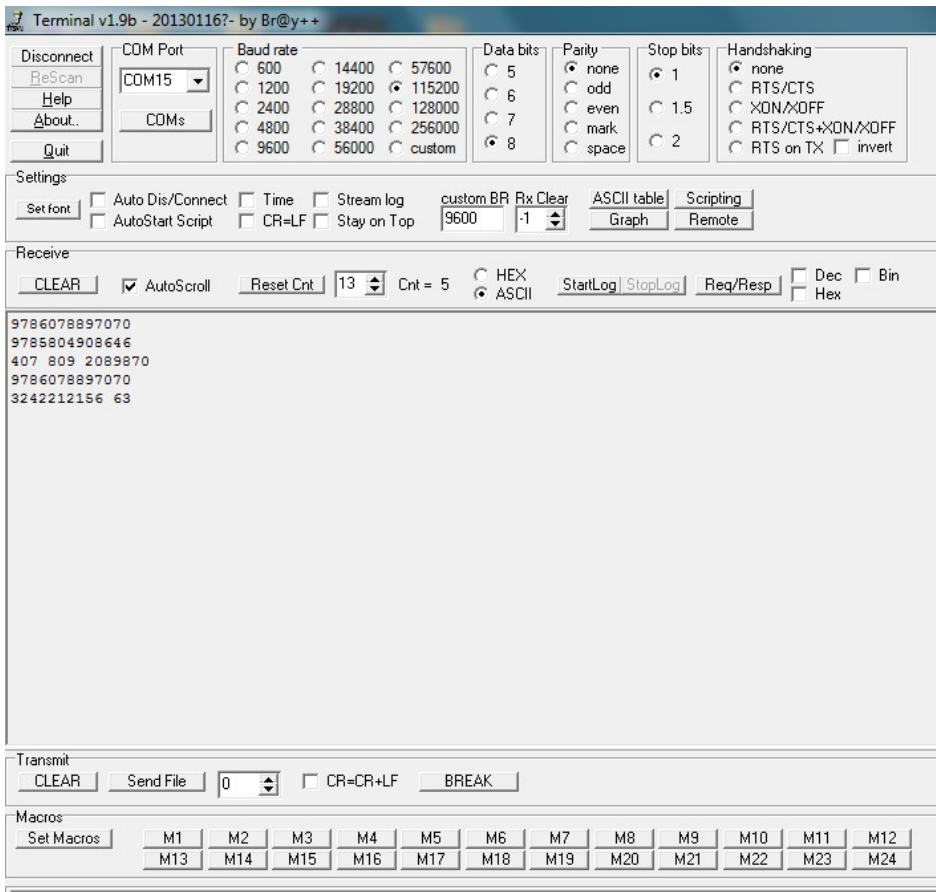

5-3 HID Mode Connection (For Third party Bluetooth devices)

- **Make sure the scanner is in Bluetooth mode; please refer to chapter 4-2-1 for how to configure in Bluetooth mode.**
- **Make sure the Mode selection code is configured as “3”. Please refer to chapter 4-2-4-3**

1. After connect Dongle and PC, it will show Bluetooth sign in system display. Click right button of the mouse and select "Add a Device". It will show screen below:

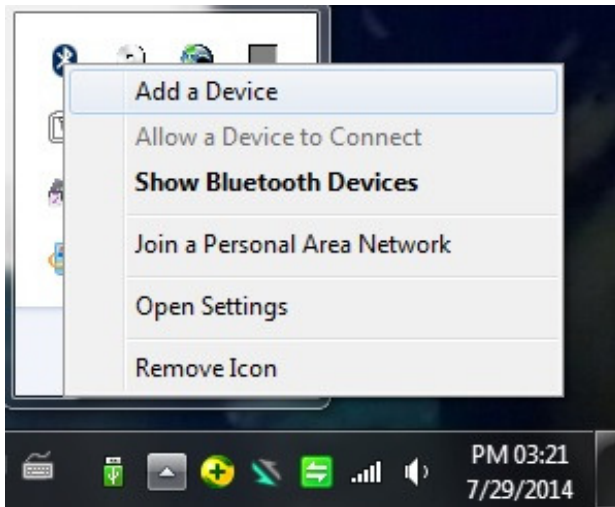

After select this function, it starts to search nearby available Bluetooth device. Make the scanner into pairing mode. In the meantime, if it can find available connecting Bluetooth device, then it will show screen below:

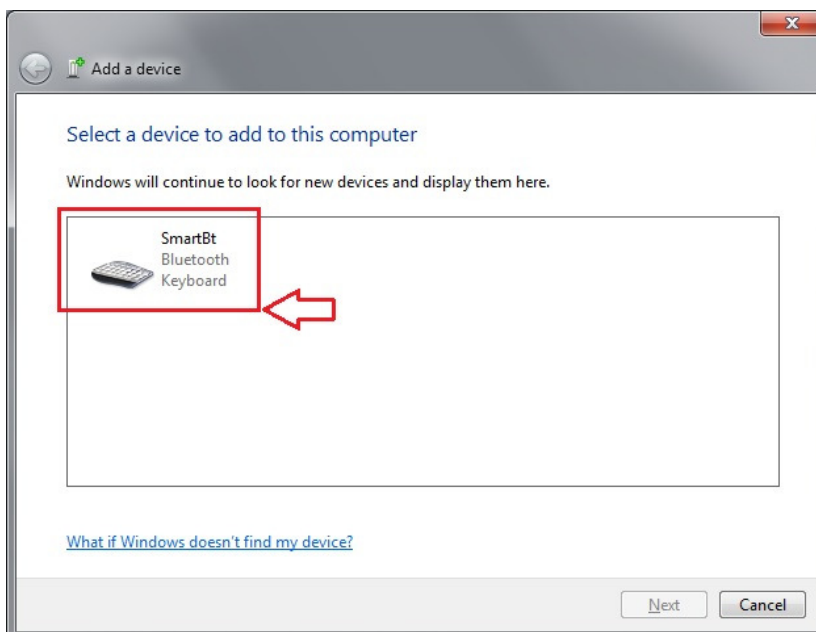

From all the finding Bluetooth device, search pairing device and click left button of the mouse. From show up window, let the user to use which way to generate

Pin Code. It will show screen below:

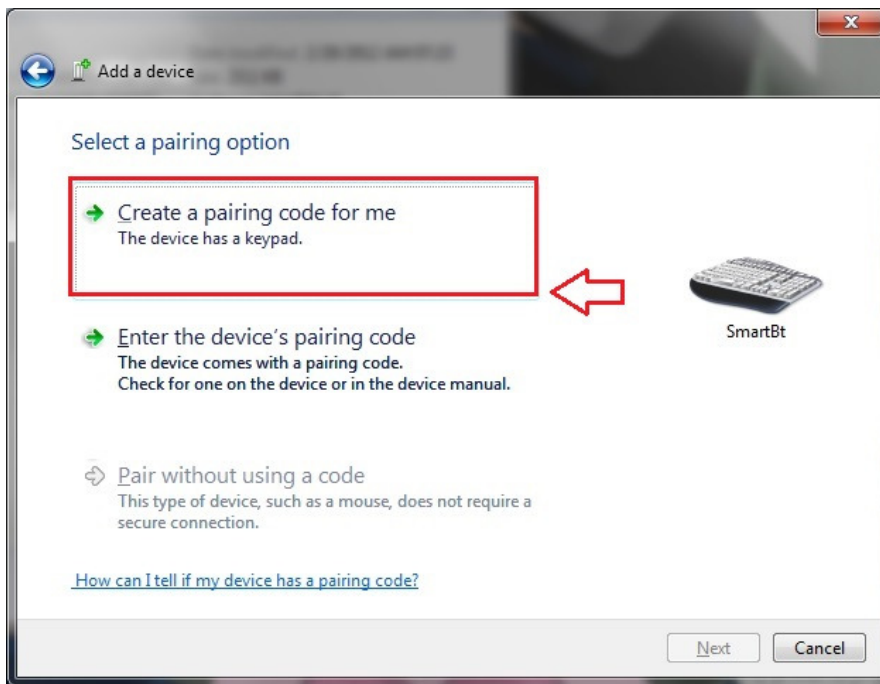

In the meantime, there are 2 ways to let user to choose the way to generate Pin Code:

2. (1).Choose "Create a pairing code for me": it will randomly generate a set of Pin Code. It will show screen below:

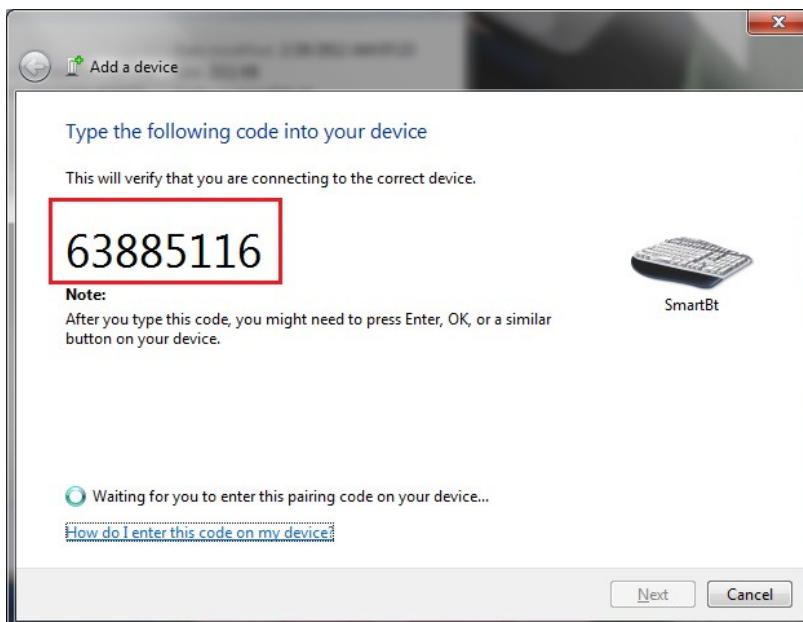

In the meantime, user can use the scanner to scan corresponding barcode in order. After finished scanning, scan "OK" barcode to finish Pin Code input. In this time, it will start to verify the Pin Code. After verified the Pin Code, it will start to connect Bluetooth connection. When it connect successfully, it will show up the following screen:

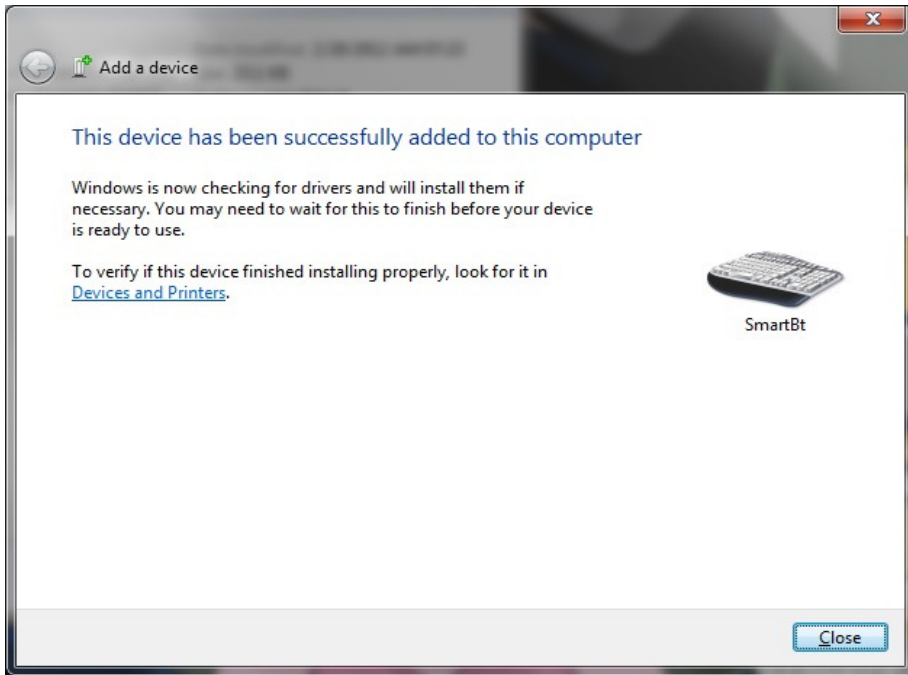

(2) Choose "Enter the device's pairing code": it will show up the following window to let the user key Pin Code. It will show screen below:

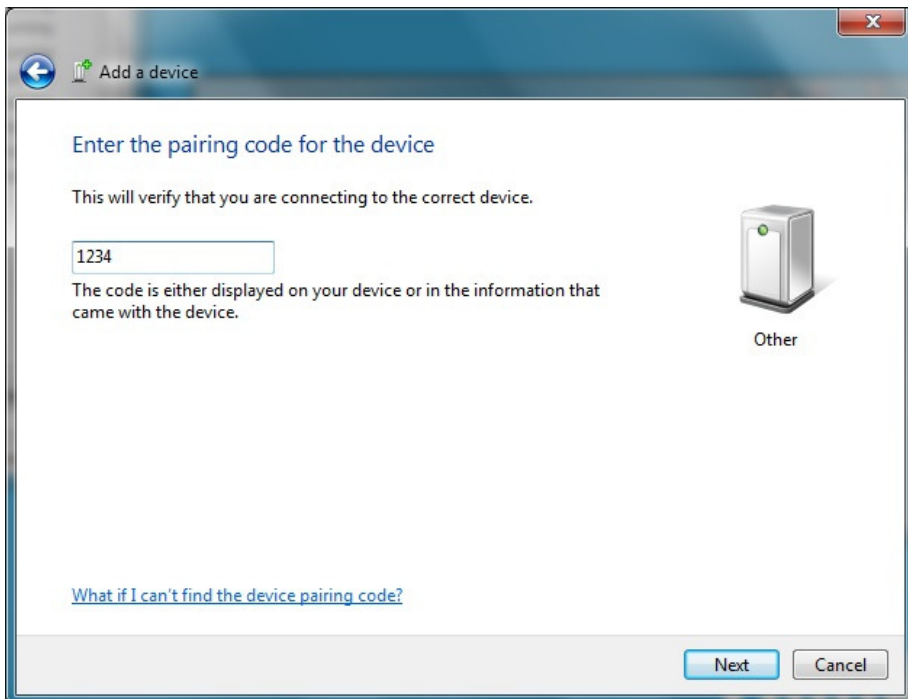

In the meantime, after clicked "Next" button, user can use the scanner to scan corresponding barcode in order. After finished scanning, scan "OK" barcode to finish Pin Code input. In this time, it will start to verify the Pin Code. After verified the Pin Code, it will start to connect Bluetooth connection. When it connect successfully, it will show up the following screen:

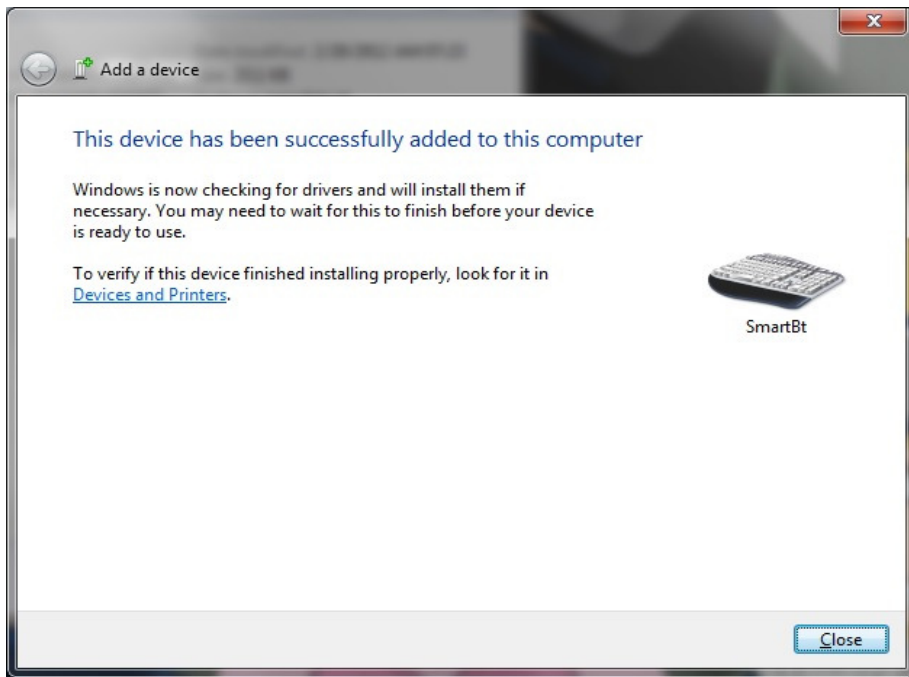

In the meantime, turn on the software to receive scanned result and scan barcode.
It will show screen below:

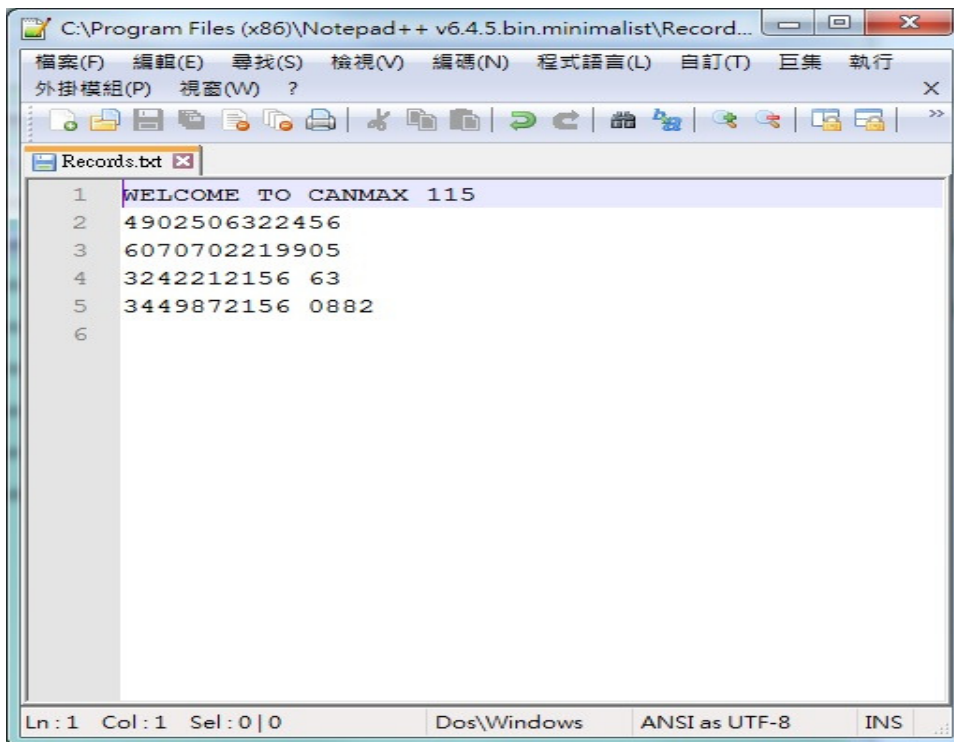

5-4 HID iOS MODE CONNECTION

- Make sure the scanner is in Bluetooth mode; please refer to chapter 4-2-1 for how to configure in Bluetooth mode.
- Make sure the Mode selection code is configured as “4”. Please refer to chapter 4-2-4-4

Please turn on iPad and select “settings” as below



Please access to General → Bluetooth → Bluetooth ON. At this stage, iPad will start searching for Bluetooth devices



From the scanner, press and hold the pairing key (small button) until the blue LED blinking, then push Scan key into pairing mode.

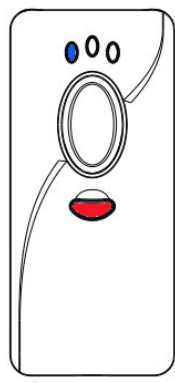

From iPad, the Bluetooth will search for the Bluetooth device ("Serial Adaptor" as scanner name)
When iPad searched "Serial Adaptor", select the device for Bluetooth pairing

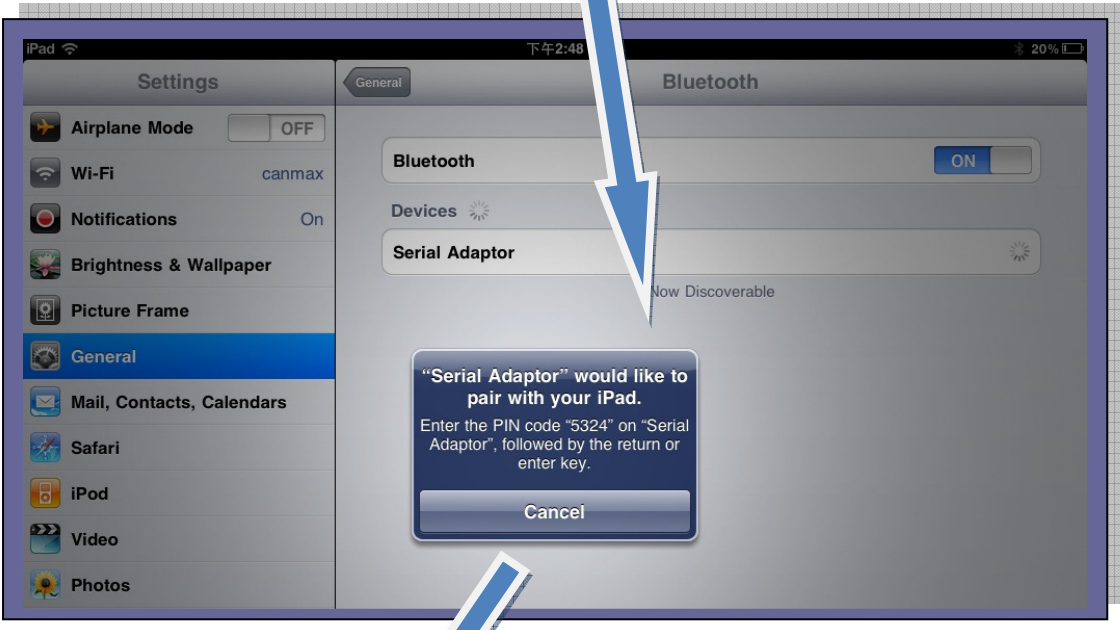
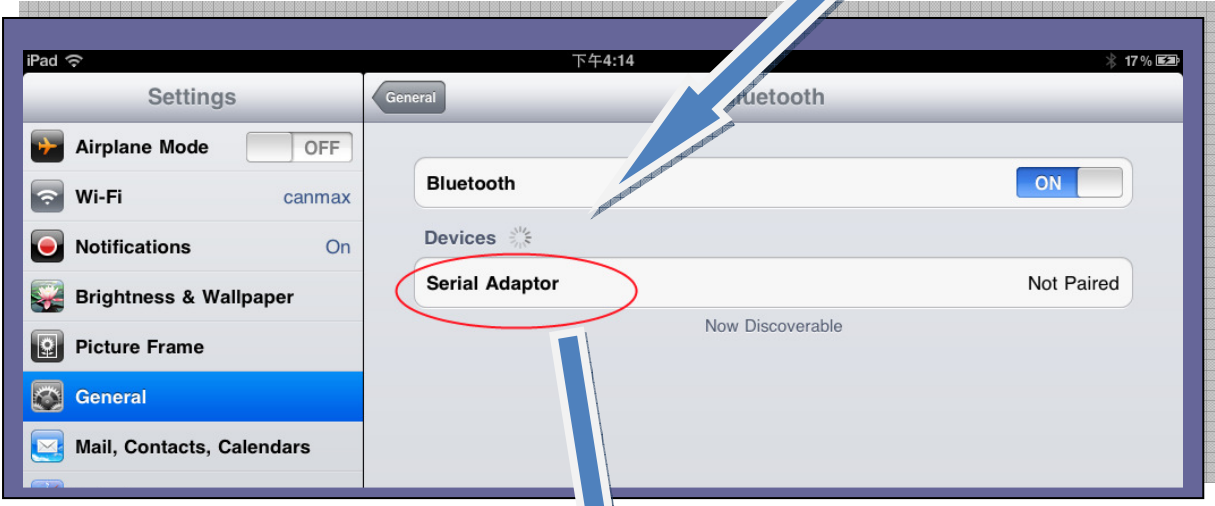

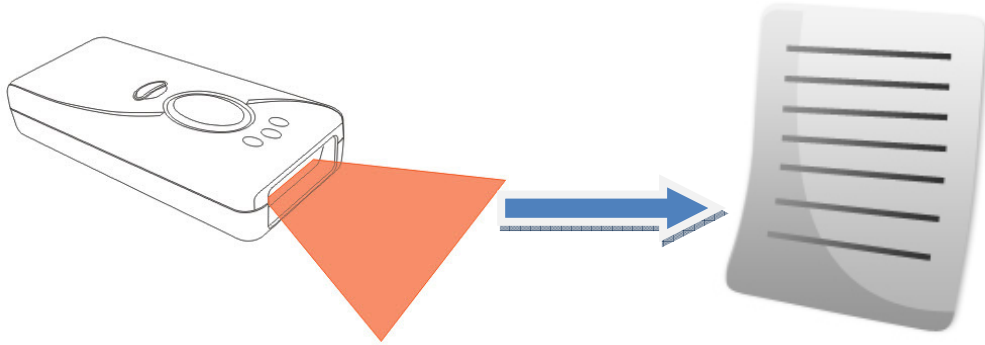

From the scanner, scan the digits appear on iPad to complete the pairing process. (Note: please print out the “Hexadecimal / Decimal table (page315)” and scan the digits, for example: “scan 5,3,2,4 → OK.”)

When the pairing processes succeed, on the iPad Bluetooth devices, it will appear as Connected. And the scanner will launch 2 beep sounds with BLUE LED indicator ON.



Now, user can access to “Notes” from iPad application to receive barcode data.



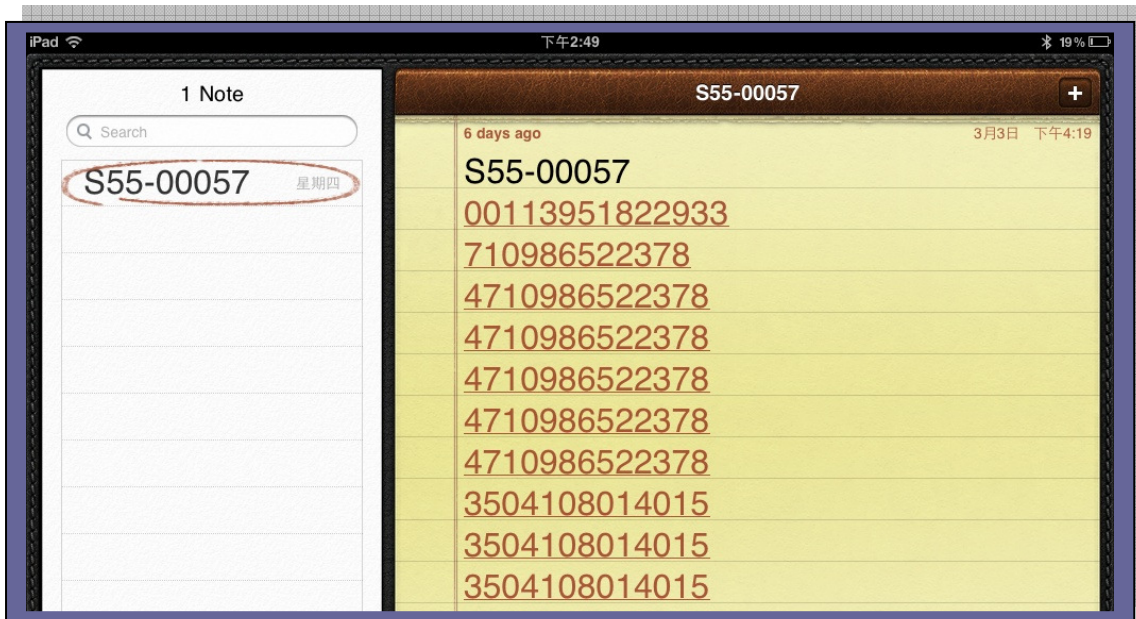

Additional Function: press the small button from the scanner once, iPad will wake up the virtual keyboard for information editing.

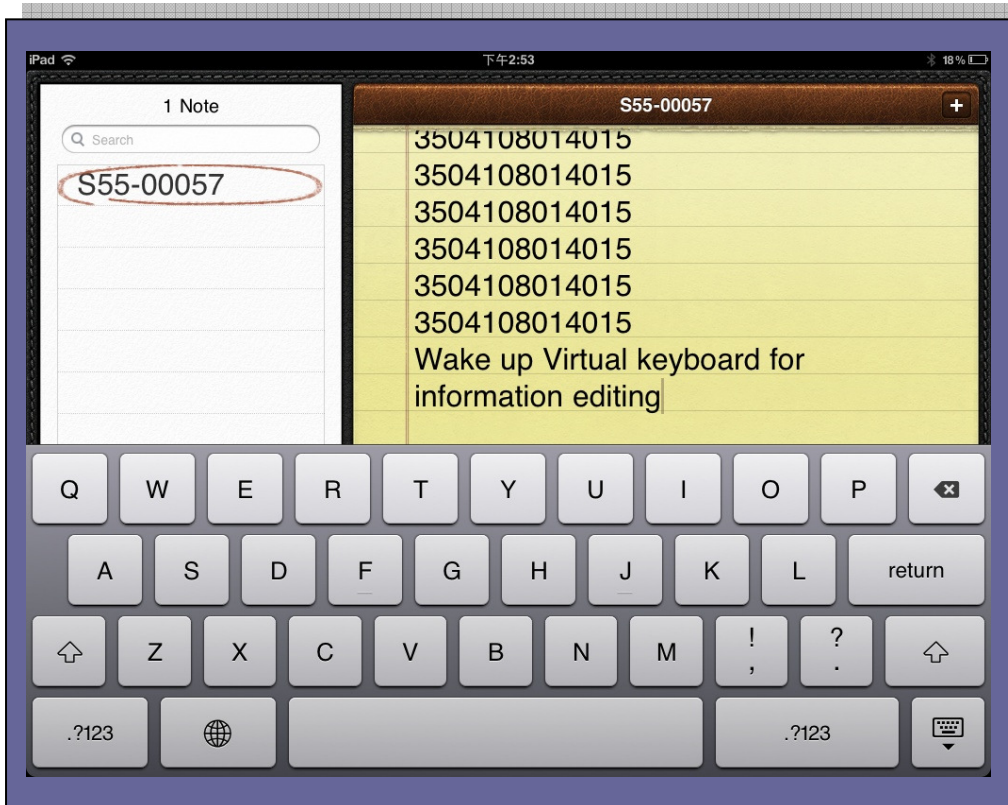
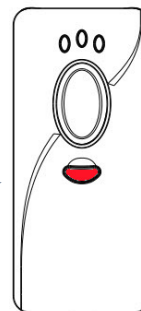

5- 5 A-303 Dongle Mode Connection (USB-HID / USB COM)

5-5-1 HID MODE:

- **Make sure the scanner is in Bluetooth mode; please refer to chapter 4-2-1 for how to configure in Bluetooth mode.**
- **Make sure the Mode selection code is configured as “5”. Please refer to chapter 4-2-4-5.**

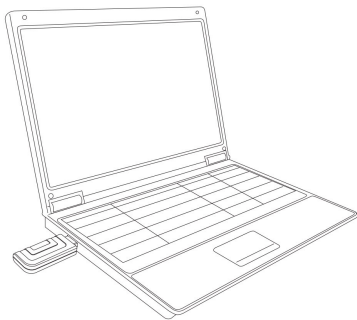

Insert Bluetooth SPP Dongle to PC.

When connecting scanner and Bluetooth Dongle, Press and hold the Pairing/delete (small) key until the blue LED blinking, then push Scan Key into pairing mode. The scanner will establish the Bluetooth connection. If connection successful, the Blue LED indicator will be on. If not, please repeat the above mention action or check the Bluetooth parameters setting.

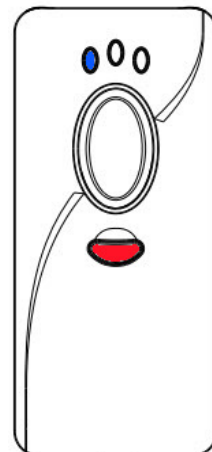

When Bluetooth Connection established, execute any word processing software, for example: Word, notepad, Excel and etc. to receive to barcode data.

5-5-2 USB COM MODE

- **Make sure the scanner is in Bluetooth mode. Please refer to above sections of how to configure in Bluetooth mode.**
- **Make sure the Mode selection code is configured as “5”. Please refer to chapter 4-2-4-5.**

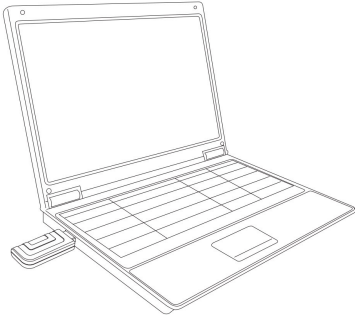

Insert Bluetooth SPP Dongle to PC.

When connecting scanner and Bluetooth Dongle, Press and hold the Pairing/delete (small) key until the blue LED blinking, then push Scan Key into pairing mode. The scanner will establish the Bluetooth connection. If connection successful, the Blue LED indicator will be on. If not, please repeat the above mention action or check the Bluetooth parameters setting.

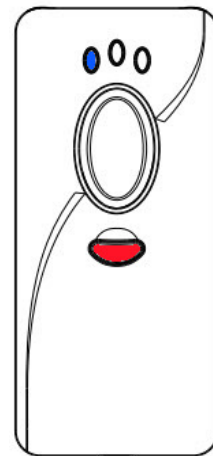

If the user wants to switch between USB-HID/ USB- COM mode, please scan the following barcode.

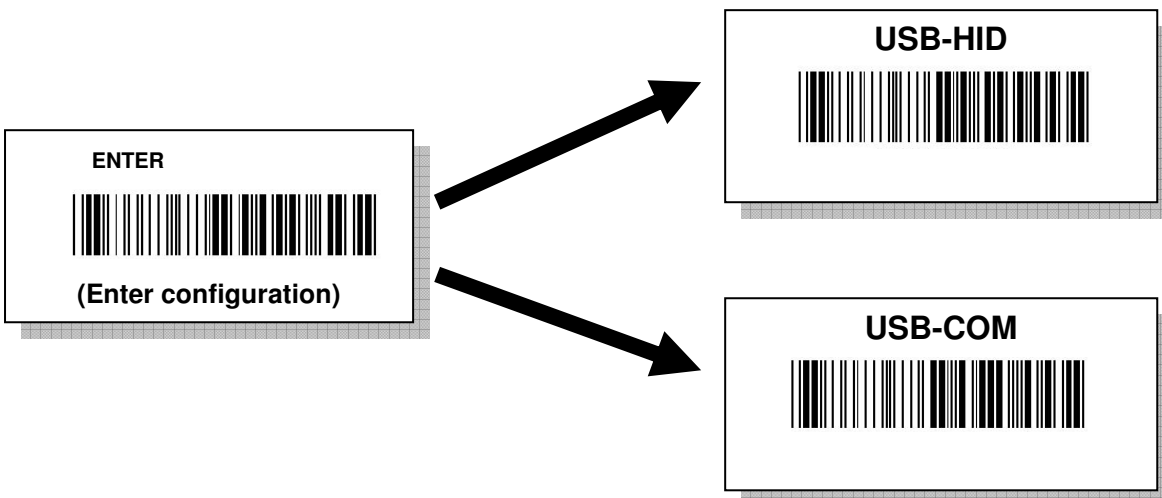

Note: Before scan the barcode, make sure the scanner and the Bluetooth Dongle is in paired status.

When under “USB COM” mode, please check device manager. You will know which COM port is available, then use Terminal program to receive scan data.

5- 6 A302 Dongle Mode Connection (USB-HID only)

- **Make sure the scanner is in Bluetooth mode. Please refer to chapter 4-2-1 for how to configure in Bluetooth mode.**
- **Make sure the Mode selection code is configured as “6”. Please refer to chapter 4-2-4-6**

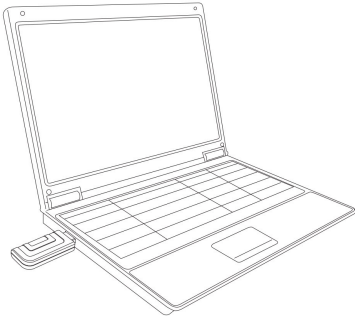

Insert Bluetooth HID Dongle to PC.

When connecting scanner and Bluetooth Dongle, Press and hold the Pairing/delete (small) key until the blue LED blinking, then push Scan Key into pairing mode. The scanner will establish the Bluetooth connection. If connection successful, the Blue LED indicator will be on. If not, please repeat the above mention action or check the Bluetooth parameters setting.

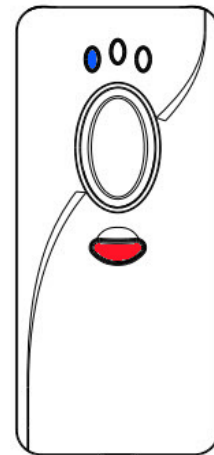

When Bluetooth Connection established, execute any word processing software, for example: Word, notepad, Excel and etc. to receive to barcode data.

5- 7 Spp-A303PT Mode Connection (USB-COM only)

- **Make sure the scanner is in Bluetooth mode. Please refer to chapter 4-2-1 for how to configure in Bluetooth mode.**
- **Make sure the Mode selection code is configured as “7”. Please refer to chapter 4-2-4-7**

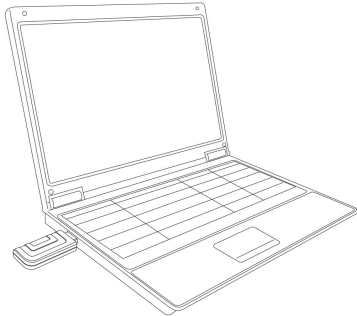

Insert Bluetooth SPP Dongle to PC.

When connecting scanner and Bluetooth Dongle, Press and hold the Pairing/delete (small) key until the blue LED blinking, then push Scan Key into pairing mode. The scanner will establish the Bluetooth connection. If connection successful, the Blue LED indicator will be on. If not, please repeat the above mention action or check the Bluetooth parameters setting.

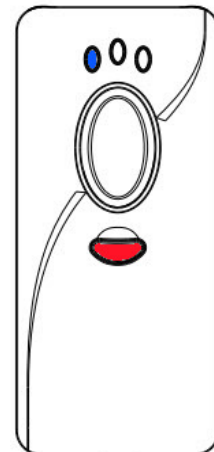

When Bluetooth Connection established, please check device manager. You will know which COM port is available, then use Terminal program to receive scan data.

Chapter 6: Memory / Bluetooth General Setting

Memory / Bluetooth/Cable General Setting

6-1 General Memory Mode Setting

- 6-1-1 Mode**
- 6-1-2 Output Interface**
- 6-1-3 Scan Activation Time**
- 6-1-4 Composite Triggers Functionality**
- 6-1-5 Small Trigger Functionality**
- 6-1-6 Battery Charge**
- 6-1-7 Power Saving Time**
- 6-1-8 Stand by Time**
- 6-1-9 Header/Footer**
- 6-1-10 Date &Time Transmission**
- 6-1-11 Date &Time Delimiter**
- 6-1-12 Delimiter Content**
- 6-1-13 Transmission Length**
- 6-1-14 Reject Same**
- 6-1-15 Good Read Beep**
- 6-1-16 Warning Beep**
- 6-1-17 Normal Beep**
- 6-1-18 Good Read Vibrator**
- 6-1-19 Warning Vibrator**
- 6-1-20 Normal Vibrator**
- 6-1-21 Vibrator Time**
- 6-1-22 Force Case**
- 6-1-23 Transmission Code ID**
- 6-1-24 Code ID Position**
- 6-1-25 Transmission Code Name**
- 6-1-26 Good Read Volume**
- 6-1-27 Warning Beep Volume**
- 6-1-28 Normal Volume**
- 6-1-29 Double Confirm**
- 6-1-30Date/Time Position**
- 6-1-31 Preamble Code**
- 6-1-32 Preamble Content**

- 6-1-33 Postamble Code
- 6-1-34 Postamble Content
- 6-1-35 Prefix Code
- 6-1-36 Prefix Content
- 6-1-37 Suffix Code
- 6-1-38 Suffix Content
- 6-1-39 Control Characters
- 6-1-40 Delimiter Code
- 6-1-41 Transmission Unit
- 6-1-42 Transmission Data All Delete

6-2 General Bluetooth Mode Setting

- 6-2-1 Mode
- 6-2-2 Output Interface
- 6-2-3 Scan Activation Time
- 6-2-4 Composite Triggers Functionality
- 6-2-5 Small Trigger Functionality
- 6-2-6 Battery Charge
- 6-2-7 Power Saving Time
- 6-2-8 Standby Time
- 6-2-9 BT Pairing
- 6-2-10 BT Pairing Time
- 6-2-11 Good Read Beep
- 6-2-12 Warning Beep
- 6-2-13 Normal Beep
- 6-2-14 Good Read Vibrator
- 6-2-15 Warning Vibrator
- 6-2-16 Normal Vibrator
- 6-2-17 Vibrator Time
- 6-2-18 Transmission Length
- 6-2-19 Force Case
- 6-2-20 Transmission Code ID
- 6-2-21 Code ID Position
- 6-2-22 Transmission Code Name
- 6-2-23 Good Read Volume
- 6-2-24 Warning Volume
- 6-2-25 Normal Volume
- 6-2-26 Beep Tone
- 6-2-27 Beep Time
- 6-2-28 Double Confirm

- 6-2-29 Date/Time Position
- 6-2-30 Preamble Code
- 6-2-31 Preamble Content
- 6-2-32 Postamble Code
- 6-2-33 Postamble Content
- 6-2-34 Prefix Code
- 6-2-35 Prefix Content
- 6-2-36 Suffix Code
- 6-2-37 Suffix Content
- 6-2-38 Control Characters
- 6-2-39 Delimiter Code
- 6-2-40 Delimiter Content
- 6-2-41 Reject Same
- 6-2-42 Date &Time Transmission
- 6-2-43 Date &Time Delimiter

6-3 General Cable Mode Setting – By User Manual

- 6-3-1 Mode
- 6-3-2 Output Interface
- 6-3-3 Scan Activation Time
- 6-3-4 Composite Triggers Functionality
- 6-3-5 Small Trigger Functionality
- 6-3-6 Battery Charge
- 6-3-7 Power Saving Time
- 6-3-8 Standby Time
- 6-3-9 Date &Time Transmission
- 6-3-10 Date &Time Delimiter
- 6-3-11 Reject Same
- 6-3-12 Good Read Beep
- 6-3-13 Warning Beep
- 6-3-14 Normal Beep
- 6-3-15 Good Read Vibrator
- 6-3-16 Warning Vibrator
- 6-3-17 Normal Vibrator
- 6-3-18 Vibrator Time
- 6-3-19 Transmission Length
- 6-3-20 Force Case
- 6-3-21 Transmission Code ID
- 6-3-22 Code ID Postition
- 6-3-23 Transmission Code Name

6-3-24 Good Read Volume

6-3-25 Warning Volume

6-3-26 Normal Volume

6-3-27 Beep Tone

6-3-28 Beep Time

6-3-29 Double Confirm

6-3-30 Date/Time Position

6-3-31 Preamble Code

6-3-32 Preamble Content

6-3-33 Postamble Code

6-3-34 Postamble Content

6-3-35 Prefix Code

6-3-36 Prefix Content

6-3-37 Suffix Code

6-3-38 Suffix Content

6-3-39 Control Characters

6-3-40 Delimiter Code

6-3-41 Delimiter Content

6-4 Scanner Configuration by Software

6-4-1 Firmware update

6-4-2 Scanner Configuration





6. Memory / Bluetooth/ Cable General

6-1 General Memory Mode Setting

6-1-1 Mode

This function to set operation Mode:





- (1) **Good Read Off**: When pressing “Scan” key, turning on scanning light, scanning barcode correctly or over loading time to make barcode scanning incorrectly, the light will be turned off.
- (2) **Momentary**: When pressing “Scan” key, turning on scanning light, scanning barcode correctly or release “Scan” key, the light will be turned off.
- (3) **Continue**: When pressing “Scan” key, turning on scanning light, No need to press the trigger then the scanner can read barcode when the LED light source is on.
- (4) **Toggle**: Scan Toggle label if you intend to gain more flexibility in when to read a barcode. A press on Scan Button will lead in switching on the light whereas either a successful decoding of a barcode or giving it another press correspondingly switches off the light. Please scan the appropriate label to determine your preferred scan mode.

 * B E 0 8 0 * Good Read Off
 * B E 0 8 1 * Momentary
 * B E 0 8 2 * Continue
 * B E 0 8 3 * Toggle



6-1-2 Output Interface

Please scan the appropriate barcode to specify the output interface

 * B E 1 D 0 *
AppStd
 * B E 1 D 1 *
Usb-Hid
 * B E 1 D 2 *
Usb-Spp
 * B E 1 D 3 *
Spp
 * B E 1 D 4 *
Usb-Mass

Enter



75

End



6-1-3 Scan Activation Time

In general, after Scan Button is pressed down, LED light will emit a stream of light for a scan attempt. This parameter is thus used to specify activation duration which indicates the amount of time LED light will stays on after Scan button is held.



Configuration Range	Unit	Default Setting
5 Secs ~ 4 Min 15 Secs	1 Secs	10 Secs

- (A) Scan “Enter” barcode
- (B) Scan “Scan Activation Time” barcode
- (C) Scan parameters from Hexadecimal / Decimal table
- (D) Scan “OK” barcode
- (E) Scan “End” barcode

6-1-4 Composite Triggers Functionality

Some supplementary functions are necessarily executed by using composite triggers though Scan Button primarily serves to scan barcodes, and Small Trigger to initiate data transmission. In Memory mode, all the scanned barcode data will be deleted by pressing small trigger and Scan button in a specified sequence described below: while holding the smaller till the orange LED light starts flashing rapidly, press down Scan button at the same time and then release both buttons. Scan the appropriate label to enable or disable functionality of file deletion.

* B E 2 8 0 *

Disable

* B E 2 8 1 *

DelAll



6-1-5 Small Trigger Functionality

Small Trigger is designed to perform various supplementary operations, from deleting single scanned data charge to switching to data transmission mode, according to the length of time the button has been pressed. To facilitate the associated operations with Small Trigger, this parameter is available to specify the degree of Small Trigger's functionality. Scan **Disable** label to specify Small Trigger will not provide any additional function. On the other hand, when **Mem Tx** is enabled, the device able to switch to data transmission mode. By default, Small Trigger is set for maximum functionality without limit.



6-1-6 Battery Charge

Scan the appropriate barcode to determine whether to initiate battery charge whenever the device is well connected to host PC using an interface cable.

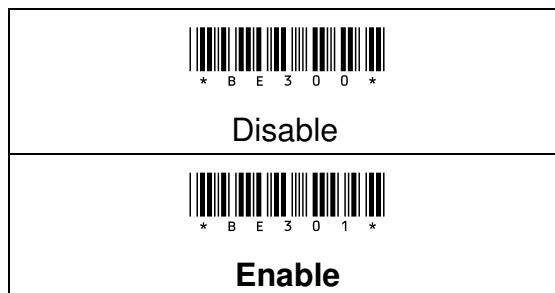

6-1-7 Power Saving Time

The device will switch to power-saving mode after remaining idle for a while. This parameter is thus used to specify the length of time allocated for the scanner to elapse before power-saving mode is initiated.



* B F E E O *

Configuration Range	Unit	Default Setting
0 Secs ~ 4 Min 15 Secs	1 Secs	0 Secs

- (A) Scan "Enter" barcode
- (B) Scan "Power Saving Time" barcode
- (C) Scan parameters from Hexadecimal / Decimal table
- (D) Scan "OK" barcode
- (E) Scan "End" barcode

Enter



78

End



6-1-8 Stand by Time

After lengthy idleness, the device will first be put into standby state in which the machine is still able to react to the emergent request yet running in lower power consumption. This parameter refers to the amount of time allocated for the device to stay in standby before being totally shut down.



Configuration Range	Unit	Default Setting
1 0Secs ~ 4 Min 15 Secs	1 Sec	10 Secs

Procedure	Example
(A) Scan "Enter" barcode (B) Scan "Stand by time" barcode (C) Scan parameters from Hexadecimal / Decimal table (D) Scan "OK" barcode (E) Scan "End" barcode	If configuration is 1 minutes, the parameter value is 1 min / 1 sec = 60



6-1-9 Header/Footer

The user push small key to transmit data from memory. The user will be able to verify the barcode data saved in the memory by the header <Header><Footer>. User can enable / Disable the function by scanning the following barcode.

Header:

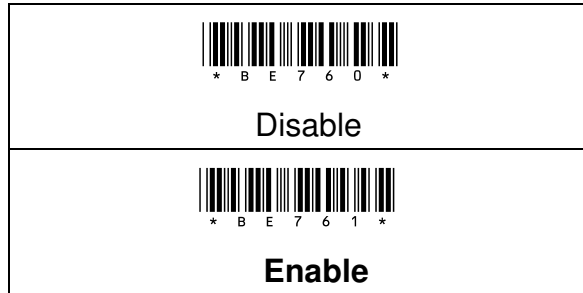

Footer:

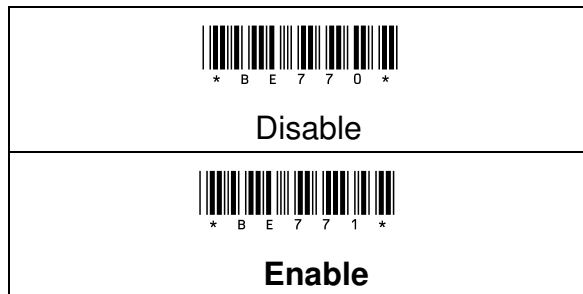

Enter



80

End



6-1-10 Date & Time Transmission

The user scans following barcode to Enable/Disable date and time for every data in memory.

Date:

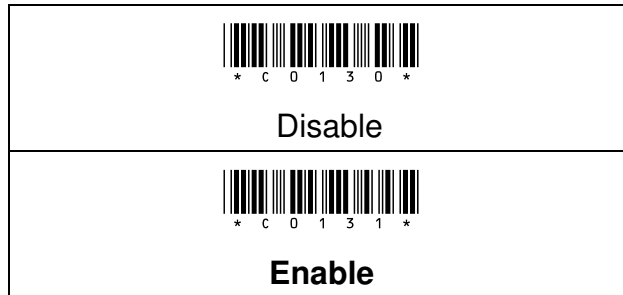

Time:

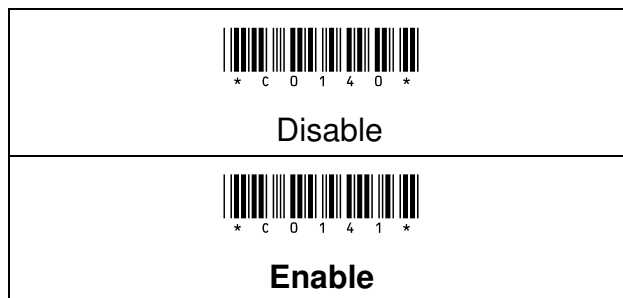

6-1-11 Date & Time Delimiter

When the display is used to set the date and time, date delimiter between date parameters and time parameters



Procedure

- (A) Scan "Enter" barcode
- (B) Scan "Date & Time Delimiter" barcode
- (C) Scan parameters from Hexadecimal / Decimal table
- (D) Scan "OK" barcode
- (E) Scan "End" barcode

Enter



81

End



6-1-12 Delimiter Content

If user want to delimit datetime & barcode. Please scan below barcode to setting.



Procedure

- (A) Scan “Enter” barcode
- (B) Scan “Delimiter Content” barcode
- (C) Scan parameters from Hexadecimal / Decimal table
- (D) Scan “OK” barcode
- (E) Scan “End” barcode

6-1-13 Transmission Length

If user needs to know the length of the barcode data, this configuration enables to indicate the barcode length in front of barcode data.

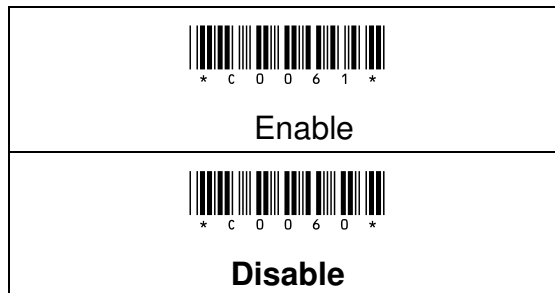

6-1-14 Reject Same

In Memory mode, the user scan the appropriate barcode to enable or disable Reject Same. This function is for prevent from same barcode scanning repeatedly.

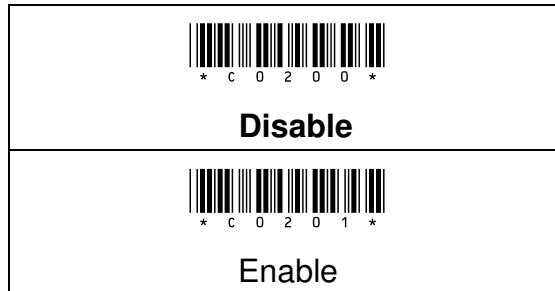

6-1-15 Good Read Beep

Scan the appropriate barcode to enable or disable Good Read Buzzer when a barcode is successfully decoded.

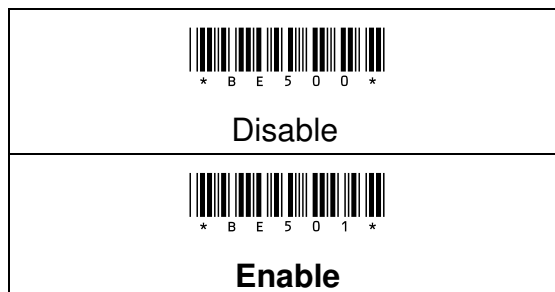

6-1-16 Warning Beep

Scan the appropriate barcode to enable or disable Warning Buzzer when an error occurs.

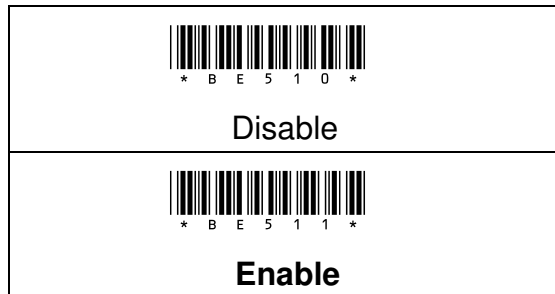

6-1-17 Normal Beep

Normal Event Buzzer is used to give an acoustic signal whenever certain operations, Scan the appropriate barcode to enable or disable Normal Event Buzzer.

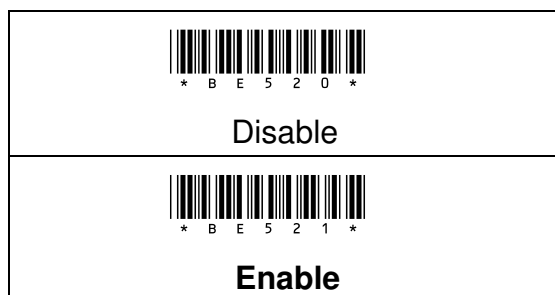

6-1-18 Good Read Vibrator

Scan the appropriate barcode to enable or disable Good Read Vibrator when a barcode is successfully decoded.

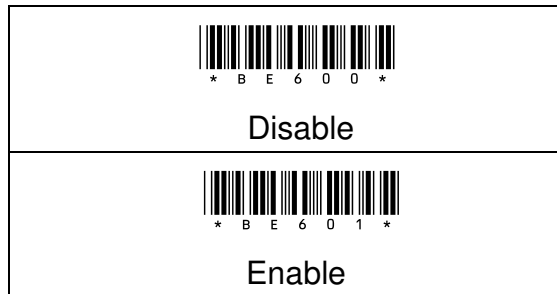

6-1-19 Warning Vibrator

Scan the appropriate barcode to enable or disable Warning Vibrator when an error occurs.

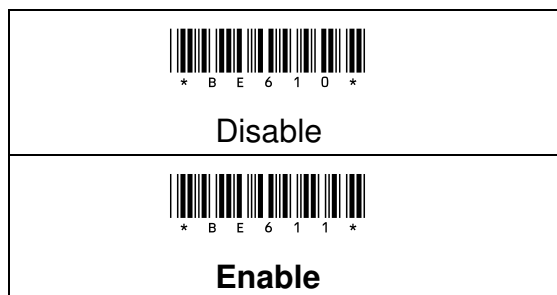

6-1-20 Normal Vibrator

Normal Event Vibrator is used to give a vibration signal whenever certain operations, Scan the appropriate barcode to enable or disable Normal Event Vibrator.

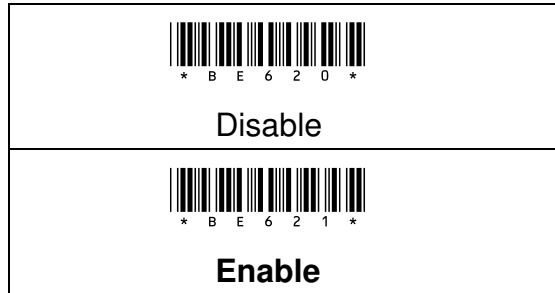

6-1-21 Viberator Time

Please follow the below steps to specify the length of time the device stays in a state of vibration when a barcode is decoded successfully



Configuration Range	Unit	Default Setting
0.02 Secs ~ 2.55 Secs	0.01 Sec	0.05 Secs

Procedure

- (A) Scan "Enter" barcode
- (B) Scan "Viberator Time" barcode
- (C) Scan parameters from Hexadecimal / Decimal table
- (D) Scan "OK" barcode
- (E) Scan "End" barcode

Enter



End



6-1-22 Force Case

This configuration enables to convert all output digits to be same printing-case; even one barcode may have two kinds of case

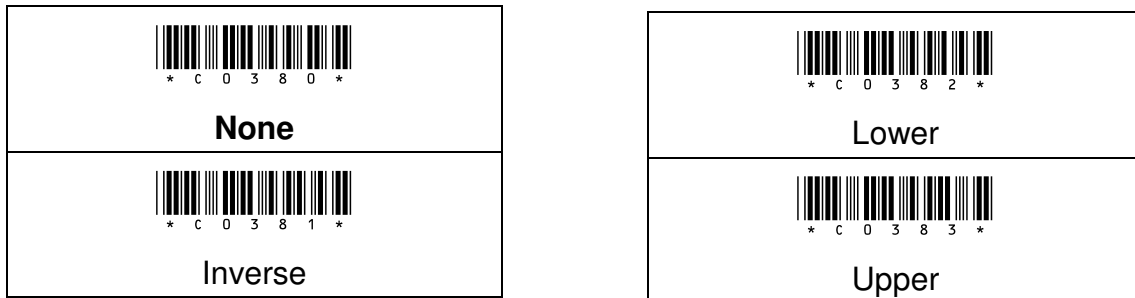

6-1-23 Transmission Code ID

When scanning the barcode, User might want to know the symbology of the barcode ID, This configuration enables to display the Code ID or Sub Code ID.

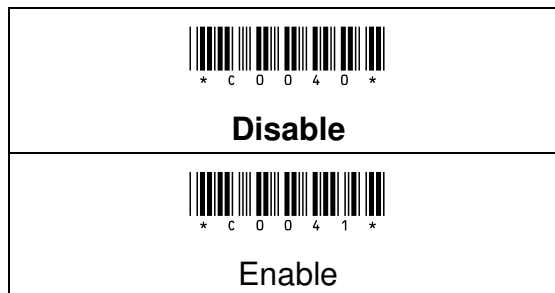

Enter



87

End



6-1-24 Code ID Position

When “Transmission Code ID” is “Enable”, user can configure the output position of Code ID or Sub Code ID (Before Barcode/ After Barcode).

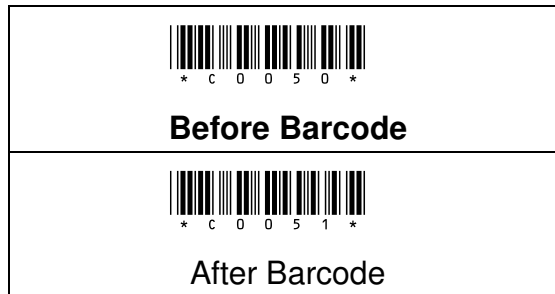



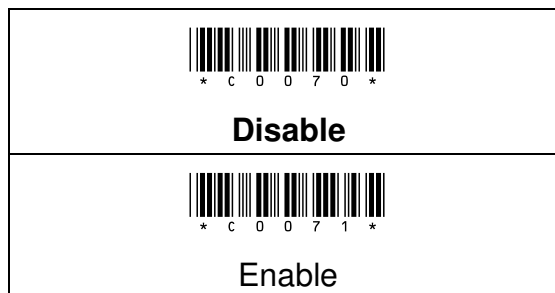

6-1-25 Transmission Code Name

This configuration enables to show the barcode symbology name. Symbology name will be showing in front of barcode data.







6-1-26 Good Read Volume

Scan the appropriate barcode to specify the volume of Good Read Buzzer when a barcode is decoded successfully. The higher level indicates the louder sound.

 * B E 4 8 0 * Level1
 * B E 4 8 1 * Level2
 * B E 4 8 2 * Level3
 * B E 4 8 3 * Level4

6-1-27 Warning Beep Volume

Scan the appropriate barcode to specify the volume of Warning Buzzer when an error occurs. The higher level indicates the louder sound.

 * B E 4 9 0 * Level1
 * B E 4 9 1 * Level2
 * B E 4 9 2 * Level3
 * B E 4 9 3 * Level4

Enter



89

End



6-1-28 Normal Volume

Scan the appropriate barcode to specify the volume of Normal Event Buzzer when certain operations, such as switching operation modes, entering data transmission mode, and deleting all saved barcodes, are initiated by using Scan Button or Small Trigger so that LED indicator accordingly changes its blinking frequency or color. The higher level indicates the louder sound.

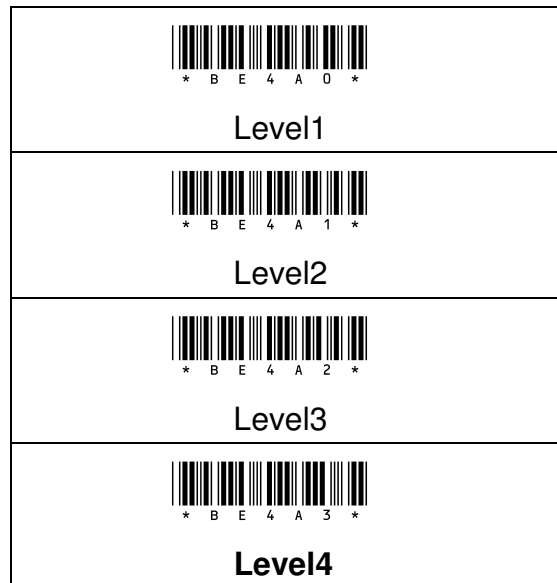

6-1-29 Double Confirm

This option enables the scanner to double confirm the barcode data, if this option is enabled, the scanner will require more times to verify the barcode data. This setting will related to the double confirm count configuration, the more confirm counts will inhibit miss-reading barcodes.

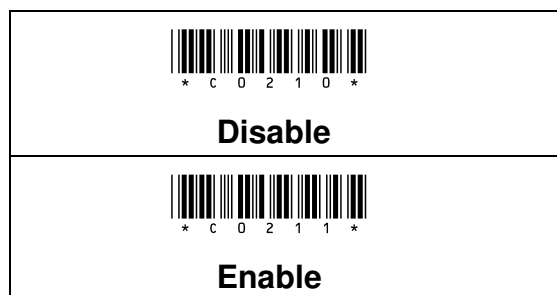

Enter



90

End



6-1-30 Date/Time Position

If you want to display data from Memory, you can use this function to set Date/Time position. Date and Time Transmission must be enabled and configure the following formats: (**chapter: 6-1-10**)



6-1-31 Preamble code

Preamble Code refers to a sequence of characters which precedes both Prefix Code and barcode data during data transmission. Scan the appropriate barcode to enable or disable Preamble Code.

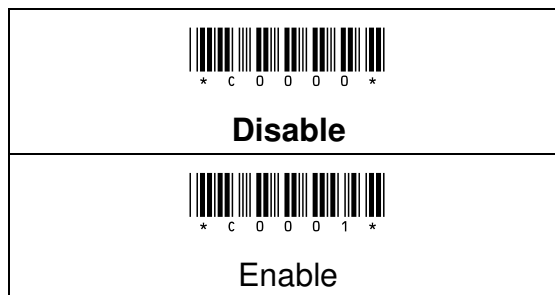

6-1-32 Preamble Content

Setting Preamble code content



Procedure

- (A) Scan “Enter” barcode
- (B) Scan “Preamble Content” barcode
- (C) Scan parameters from Hexadecimal / Decimal table
- (D) Scan “OK” barcode
- (E) Scan “End” barcode

6-1-33 Postamble Code

Postamble Code refers to a sequence of characters which appends to both barcode data and Suffix Code during data transmission. Scan the appropriate barcode to enable or disable Postamble Code.

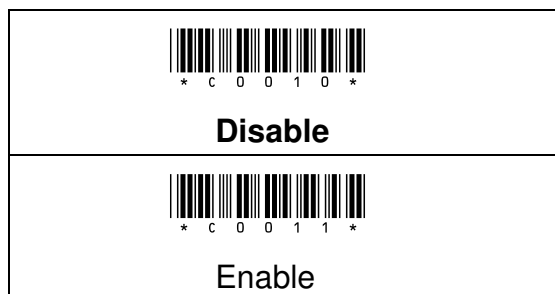

Enter



92

End



6-1-34 Postamble Content

Setting Postamble code content

Procedure

- (A) Scan "Enter" barcode
- (B) Scan "Postamble Content" barcode
- (C) Scan parameters from Hexadecimal / Decimal table
- (D) Scan "OK" barcode
- (E) Scan "End" barcode

6-1-35 Prefix Code

Prefix Code is a sequence of characters interposed between Preamble Code and barcode data during data transmission. Scan the appropriate barcode to enable or disable Prefix Code

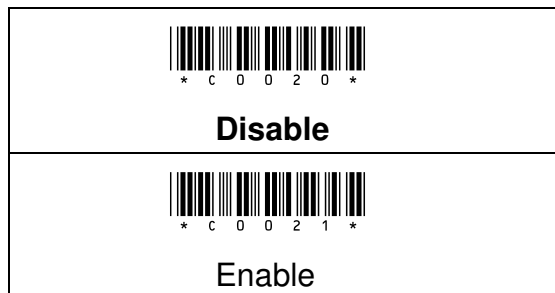

Enter



93

End



6-1-36 Prefix Content

Setting Prefix code content



Procedure

- (A) Scan "Enter" barcode
- (B) Scan "Prefix Content" barcode
- (C) Scan parameters from Hexadecimal / Decimal table
- (D) Scan "OK" barcode
- (E) Scan "End" barcode

6-1-37 Suffix Code

Suffix Code is a sequence of characters interposed between barcode data and Postamble Code during data transmission. Scan the appropriate barcode to enable or disable Suffix Code.

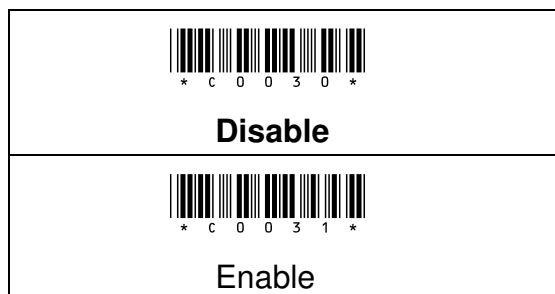

Enter



94

End



6-1-38 Suffix Content

Setting Suffix code content



Procedure

- (A) Scan "Enter" barcode
- (B) Scan "Suffix Content" barcode
- (C) Scan parameters from Hexadecimal / Decimal table
- (D) Scan "OK" barcode
- (E) Scan "End" barcode

6-1-39 Control Characters

Scan the appropriate barcode to determine whether or not to transmit control code info along with the decoded message if the scanned barcode contains the special ASCII code.

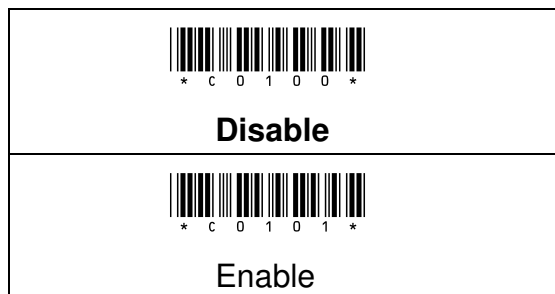

Enter



95

End



6-1-40 Delimiter code

Scan the appropriate barcode to determine whether or not to interpose the delimiter parameter between the decoded message and timestamps.

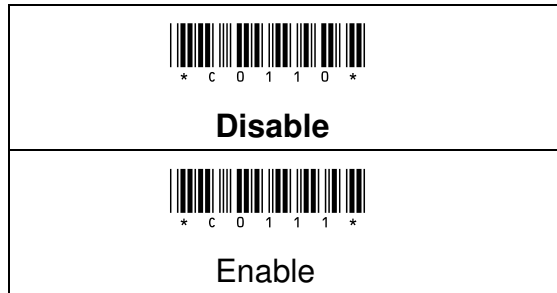

6-1-41 Transmission Unit

Set the transmission mode to the batch transfer or single

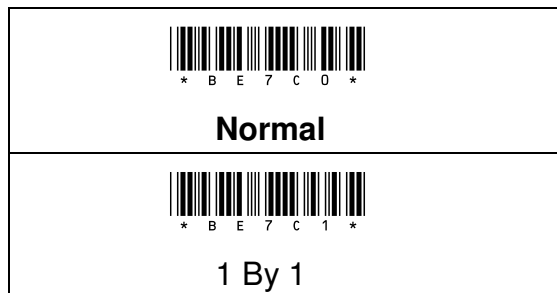

Enter



96

End



6-1-42 Transmission Data All Delete

Memory after sending the data, whether to remove all data in Memory

 * B E 7 A 0 * None
 * B E 7 A 1 * DelAll

Enter



97

End



6-2 General Bluetooth Mode Setting

6-2-1 BT Mode





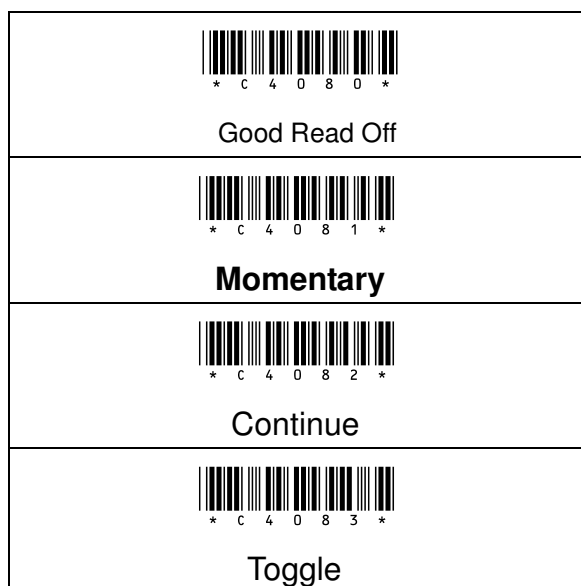

This function to set operation Mode:

- (1) **Good Read Off:** When pressing “Scan” key, turning on scanning light, scanning barcode correctly or over loading time to make barcode scanning incorrectly, the light will be turned off.
- (2) **Momentary:** When pressing “Scan” key, turning on scanning light, scanning barcode correctly or release “Scan” key, the light will be turned off.
- (3) **Continue:** When pressing “Scan” key, turning on scanning light, No need to press the trigger then the scanner can read barcode when the LED light source is on.
- (4) **Toggle:** Scan Toggle label if you intend to gain more flexibility in when to read a barcode. A press on Scan Button will lead in switching on the light whereas either a successful decoding of a barcode or giving it another press correspondingly switches off the light. Please scan the appropriate label to determine your preferred scan mode.



6-2-2 Output Interface

Please scan the appropriate barcode to specify the output interface

 * C 4 1 D 1 *
Spp-Slave
 * C 4 1 D 2 *
Spp-Master
 * C 4 1 D 3 *
Hid
 * C 4 1 D 4 *
Hid-iOS
 * C 4 1 D 5 *
Hid-A303
 * C 4 1 D 6 *
Hid-A302
 * C 4 1 D 7 *
Spp-A303PT

Enter



99

End



6-2-3 Scan Activation Time

In general, after Scan Button is pressed down, LED light will emit a stream of light for a scan attempt. This parameter is thus used to specify activation duration which indicates the amount of time LED light will stays on after Scan button is held.





Configuration Range	Unit	Default Setting
5 Secs ~ 4 Min 15 Secs	1 Secs	10 Secs

Procedure

- (A) Scan “Enter” barcode
- (B) Scan “Scan Activation Time” barcode
- (C) Scan parameters from Hexadecimal / Decimal table
- (D) Scan “OK” barcode
- (E) Scan “End” barcode

6-2-4 Composite Triggers Functionality

Some supplementary functions are necessarily executed by using composite triggers though Scan Button primarily serves to scan barcodes, and Small Trigger to initiate data transmission. In Bluetooth mode, Bluetooth pairing is an extra function which can be initiated by pressing Small Trigger and Scan Button in a specified sequence described below: while holding Small Trigger till the blue LED light starts flashing rapidly, press down Scan Button at the same time and then release both buttons. Scan the appropriate label to enable or disable pairing functionality.

 * C 4 2 8 0 * Disable	 * C 4 2 8 1 * Pairing
---	--



6-2-5 Small Trigger Functionality

Small Trigger is designed to perform various supplementary operations, from initiating battery charge to switching to data transmission mode, according to the length of time the button has been pressed. To facilitate the associated operations with Small Trigger, this parameter is available to specify the degree of Small Trigger's functionality. Scan **Disable** label to specify Small Trigger will not provide any additional function. On the other hand, when **Mem Tx** is enabled, the device is able to switch to data transmission mode by keep holding Small Trigger till the blue LED as solid color, then release Small Trigger to into Transmit mode; at this moment, push Scan key will transmit the stored data.

By default, Small Trigger is set for maximum functionality without limit.

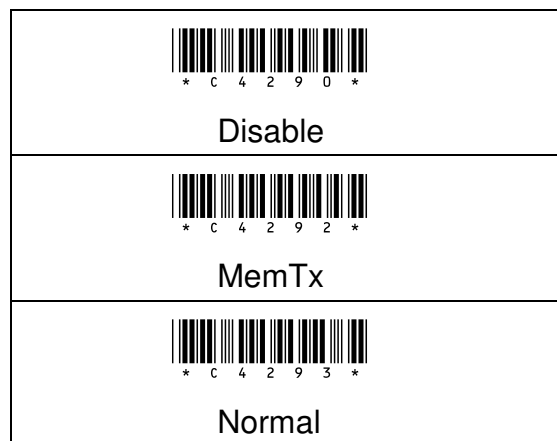

6-2-6 Battery Charge

Scan the appropriate barcode to determine whether to initiate battery charge whenever the device is well secured into host PC using an interface cable.

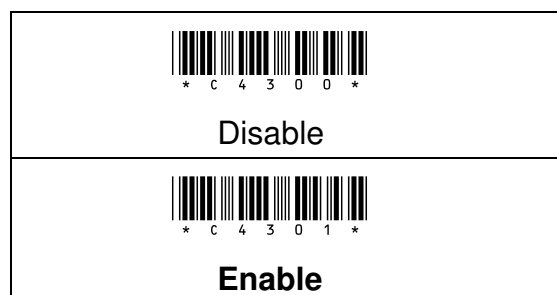

Enter



101

End



6-2-7 Power Saving Time

The device will switch to power-saving mode after remaining idle for a while. This parameter is thus used to specify the length of time allocated for the scanner to elapse before power-saving mode is initiated.



Configuration Range	Unit	Default Setting
0 Secs ~ 4 Min 15 Secs	1 Secs	0 Secs

Procedure

- (A) Scan "Enter" barcode
- (B) Scan "Power Saving Time" barcode
- (C) Scan parameters from Hexadecimal / Decimal table
- (D) Scan "OK" barcode
- (E) Scan "End" barcode

Enter



102

End



6-2-8 Stand by Time

After lengthy idleness, the device will first be put into standby state in which the machine is still able to react to the emergent request yet running in lower power consumption. This parameter refers to the amount of time allocated for the device to stay in standby before being totally shut down.



Configuration Range	Unit	Default Setting
10 Secs ~ 4 Min 15 Secs	1 Secs	60 Secs

Procedure	Example
(A) Scan “Enter” barcode (B) Scan “Stand by time” barcode (C) Scan parameters from Hexadecimal / Decimal table (D) Scan “OK“ barcode (E) Scan “End” barcode	If configuration is 1 minutes, the parameter value is 1 min / 1 sec = 60

6-2-9 BT Pairing

Set up Bluetooth Pairing by scan barcode.
 Procedure is Scan “Enter” and “ BT Pairing” barcode.



Procedure:
(A) Scan “Enter” Barcode (B) Scan “BT Pairing” Barcode



6-2-10 BT Pairing Time

When timeout period expires yet the Bluetooth connection is not established, the pairing process will terminate due to the failed attempt



Procedure

- (A) Scan "Enter" barcode
- (B) Scan "BT Pairing Time" barcode
- (C) Scan parameters from Hexadecimal / Decimal table
- (D) Scan "OK" barcode
- (E) Scan "End" barcode

6-2-11 Good Read Beep

Scan the appropriate barcode to enable or disable Good Read Buzzer when a barcode is successfully decoded.



Disable



Enable

Enter



End



6-2-12 Warning Beep

Scan the appropriate barcode to enable or disable Warning Buzzer when an error occurs.

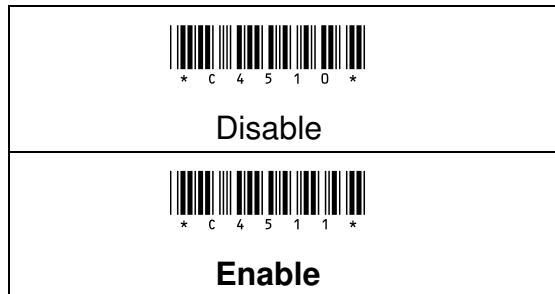

6-2-13 Normal Beep

Normal Event Buzzer is used to give an acoustic signal whenever certain operations, Scan the appropriate barcode to enable or disable Normal Event Buzzer.

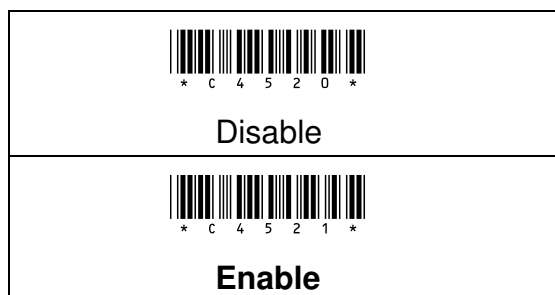

6-2-14 Good Read Vibrator

Scan the appropriate barcode to enable or disable Good Read Vibrator when a barcode is successfully decoded.

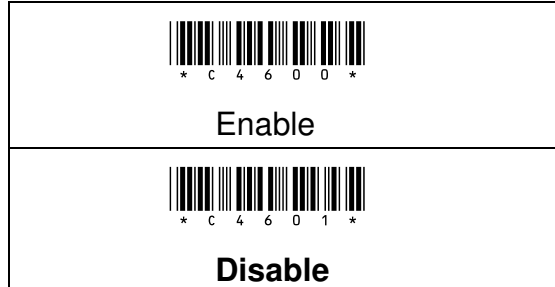

6-2-15 Warning Vibrator

Scan the appropriate barcode to enable or disable Warning Vibrator when an error occurs.

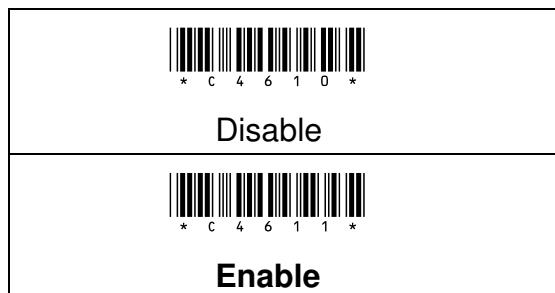

6-2-16 Normal Vibrator

Normal Event Vibrator is used to give a vibration signal whenever certain operations, such as switching operation modes, entering data transmission mode, and battery charge, are initiated by using Scan Button or Small Trigger so that LED indicator accordingly changes its blinking frequency or color. Scan the appropriate barcode to enable or disable Normal Event Vibrator.

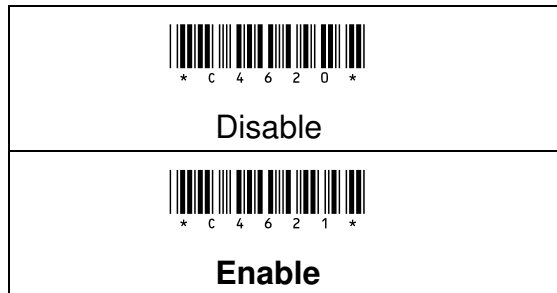

6-2-17 Viberator Time

Please follow the below steps to specify the length of time the device stays in a state of vibration when a barcode is decoded successfully



Configuration Range	Unit	Default Setting
0.02 Secs ~ 2.55 Secs	0.01 Sec	0.05 Secs

Procedure
(A) Scan "Enter" barcode
(B) Scan "Viberator Time" barcode
(C) Scan parameters from Hexadecimal / Decimal table
(D) Scan "OK" barcode
(E) Scan "End" barcode



6-2-18 Transmission Length

If user needs to know the length of the barcode data, this configuration enables to indicate the barcode length in front of barcode data.

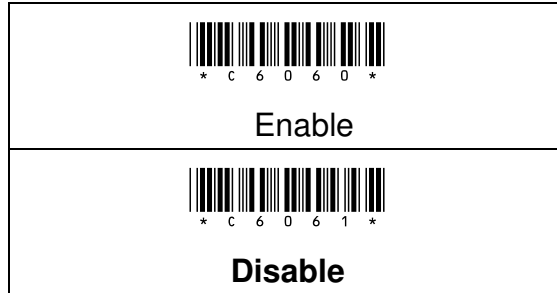

6-2-19 Force Case

This configuration enables to convert all output digits to be same printing-case; even one barcode may have two kinds of case

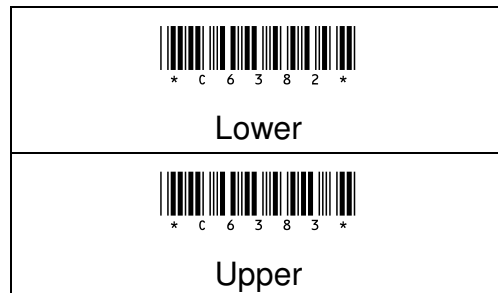
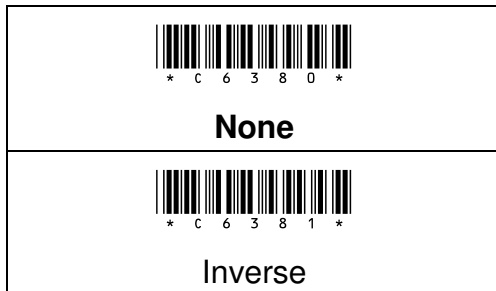

6-2-20 Transmission Code ID

When scanning the barcode, User might want to know the symbology of the barcode ID, This configuration enables to display the Code ID or Sub Code ID.

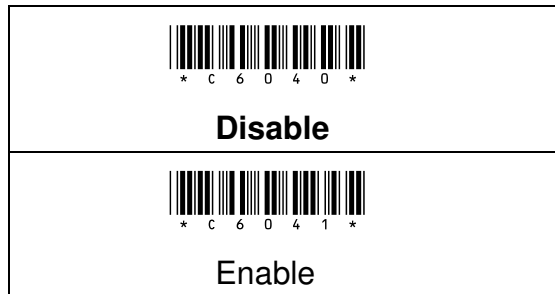

6-2-21 Code ID Position

When “Transmission Code ID” is “Enable”, user can configure the output position of Code ID or Sub Code ID (Before Barcode/ After barcode).



6-2-22 Transmission Code Name

This configuration enables to show the barcode symbology name. Symbology name will be showing in front of barcode data.

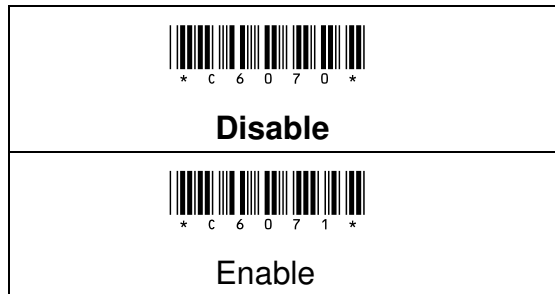



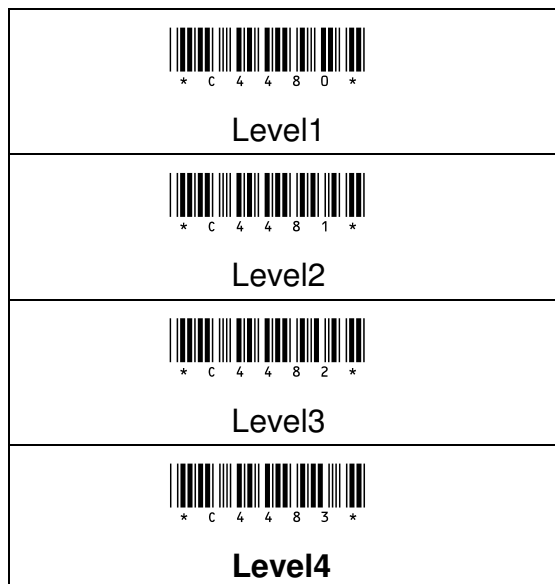

6-2-23 Good Read Volume

Scan the appropriate barcode to specify the volume of Good Read Buzzer when a barcode is decoded successfully. The higher level indicates the louder sound.



6-2-24 Warning Volume

Scan the appropriate barcode to specify the volume of Warning Buzzer when an error occurs. The higher level indicates the louder sound.

 * C 4 4 9 0 *
Level1
 * C 4 4 9 1 *
Level2
 * C 4 4 9 2 *
Level3
 * C 4 4 9 3 *
Level4

Enter







111

End



6-2-25 Normal Volume

Scan the appropriate barcode to specify the volume of Normal Event Buzzer when certain operations, such as switching operation modes, entering data transmission mode, and deleting all saved barcodes, are initiated by using Scan Button or Small Trigger so that LED indicator accordingly changes its blinking frequency or color. The higher level indicates the louder sound.

 * C 4 4 A 0 *
Level1
 * C 4 4 A 1 *
Level2
 * C 4 4 A 2 *
Level3
 * C 4 4 A 3 *
Level4



6-2-26 Beep Tone

Beep Tone configuration enables to configure the frequency of beep sound.



Configuration Range	Unit	Default Setting
100 - 5000HZ	100 HZ	2700 HZ

Procedure:	Example:
(A) Scan "Enter" barcode (B) Scan "Beep Tone" barcode (C) Scan parameters from Hexadecimal / Decimal table (D) Scan "OK" barcode (E) Scan "End" barcode	If configuration is 3000 Hz, the parameter value is 3000Hz / 100 Hz = 30

6-2-27 Beep Time

Beep time configuration enables to configure the duration of the beep sound.



Configuration Range	Unit	Default Setting
0.01 Sec ~ 2.5 Sec	0.01 sec	0.1 sec

Procedure:	Example:
(A) Scan "Enter" barcode (B) Scan "Beep Time" barcode (C) Scan parameters from Hexadecimal / Decimal table (D) Scan "OK" barcode (E) Scan "End" barcode	If configuration is 0.2 sec, the parameter value is 0.2 sec / 0.01 sec = 20



6-2-28 Double Confirm

This option enables the scanner to double confirm the barcode data, if this option is enabled, the scanner will require more times to verify the barcode data. This setting will related to the double confirm count configuration, the more confirm counts will inhibit miss-reading barcodes.

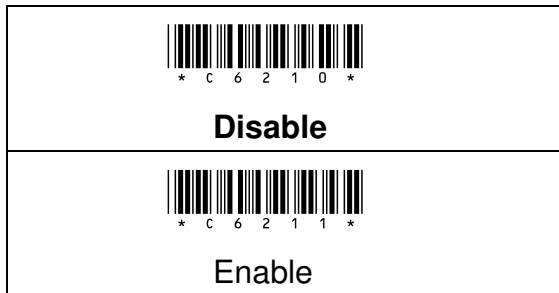

6-2-29 Date/TimePosition

If you want to display data, you can use this function to set Date/Time position. Date and Time Transmission must be enabled and configure the following formats: (**chapter: 6-2-42**)



6-2-30 Preamble Code

Preamble Code refers to a sequence of characters which precedes both Prefix Code and barcode data during data transmission. Scan the appropriate barcode to enable or disable Preamble Code.

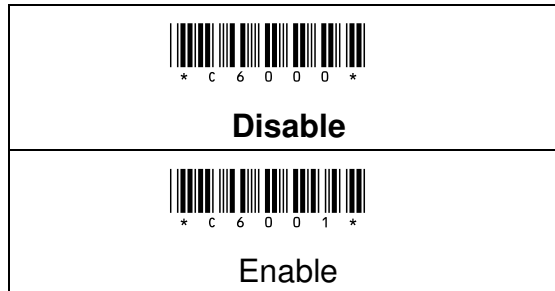

6-2-31 Preamble Content

Setting Preamble code content



Procedure

- (A) Scan "Enter" barcode
- (B) Scan "Preamble Content" barcode
- (C) Scan parameters from Hexadecimal / Decimal table
- (D) Scan "OK" barcode
- (E) Scan "End" barcode

Enter



115

End



6-2-32 Postamble Code

Postamble Code refers to a sequence of characters which appends to both barcode data and Suffix Code during data transmission. Scan the appropriate barcode to enable or disable Postamble Code.

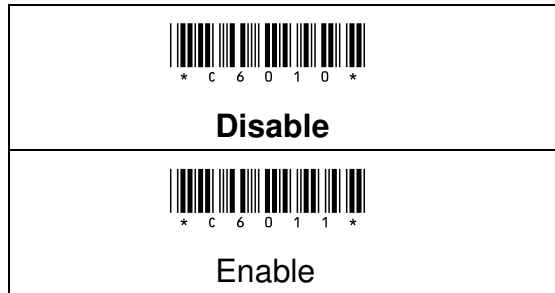

6-2-33 Postamble Content

Setting Postamble code content



Procedure
(A) Scan "Enter" barcode (B) Scan "Postamble Content" barcode (C) Scan parameters from Hexadecimal / Decimal table (D) Scan "OK" barcode (E) Scan "End" barcode

Enter



116

End



6-2-34 Prefix Code

Prefix Code is a sequence of characters interposed between Preamble Code and barcode data during data transmission. Scan the appropriate barcode to enable or disable Prefix Code

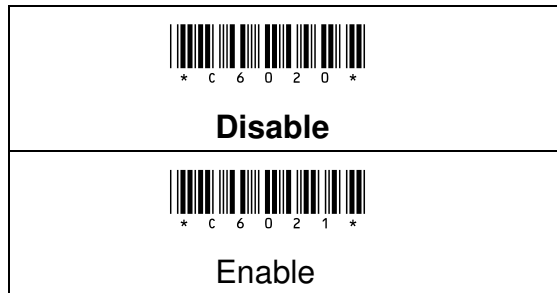

6-2-35 Prefix Content

Setting Prefix code content



Procedure

- (A) Scan "Enter" barcode
- (B) Scan "Prefix Content" barcode
- (C) Scan parameters from Hexadecimal / Decimal table
- (D) Scan "OK" barcode
- (E) Scan "End" barcode

Enter



117

End



6-2-36 Suffix Code

Suffix Code is a sequence of characters interposed between barcode data and Postamble Code during data transmission. Scan the appropriate barcode to enable or disable Suffix Code.

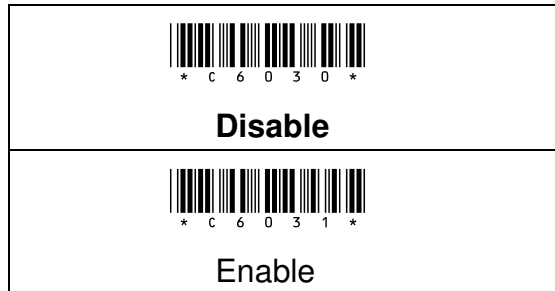

6-2-37 Suffix Content

Setting Suffix code content



Procedure
(A) Scan "Enter" barcode (B) Scan "Suffix Content" barcode (C) Scan parameters from Hexadecimal / Decimal table (D) Scan "OK" barcode (E) Scan "End" barcode

Enter



118

End



6-2-38 Control Characters

Scan the appropriate barcode to determine whether or not to transmit control code info along with the decoded message if the scanned barcode contains the special ASCII code.

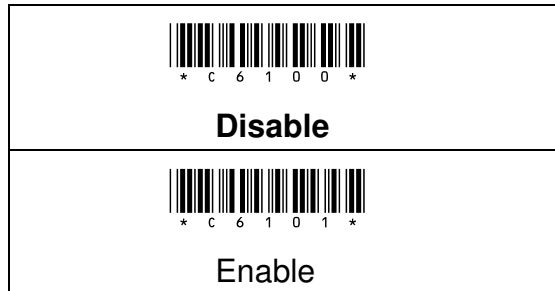

6-2-39 Delimiter code

Scan the appropriate barcode to determine whether or not to interpose the delimiter parameter between the decoded message and timestamps.

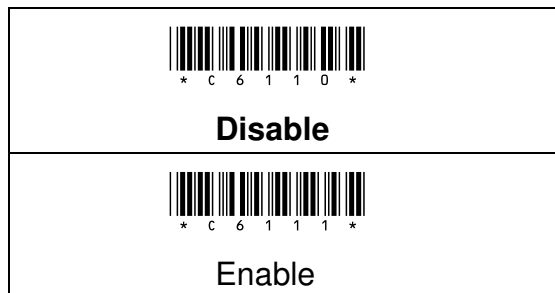

6-2-40 Delimiter Content

If user want to delimit datetime & barcode. Please scan below barcode to setting.



Procedure

- (A) Scan "Enter" barcode
- (B) Scan "Delimiter Content" barcode
- (C) Scan parameters from Hexadecimal / Decimal table
- (D) Scan "OK" barcode
- (E) Scan "End" barcode

6-2-41 Reject Same

user can configure the scanner to avoid reading the same barcode in sequent. This function is avoiding the scanner to read the same barcode by mistake.



Disable



Enable

Enter



120



End





6-2-42 Date & Time Transmission

Under Bluetooth mode, whether or not to transmit date or Time information.

Date:

 * C 6 1 3 0 * Disable
 * C 6 1 3 1 * Enable

Time:

 * C 6 1 4 0 * Disable
 * C 6 1 4 1 * Enable

6-2-43 Date & Time Delimiter

When the display is used to set the date and time, date delimiter between date parameters and time parameters



Procedure

- (A) Scan "Enter" barcode
- (B) Scan "Date & Time Delimiter" barcode
- (C) Scan parameters from Hexadecimal / Decimal table
- (D) Scan "OK" barcode
- (E) Scan "End" barcode

Enter



121

End







6-3 General Cable Mode Setting

6-3-1 Mode

This function to set operation Mode:

- (1) **Good Read Off:** When pressing “Scan” key, turning on scanning light, scanning barcode correctly or over loading time to make barcode scanning incorrectly, the light will be turned off.
- (2) **Momentary:** When pressing “Scan” key, turning on scanning light, scanning barcode correctly or release “Scan” key, the light will be turned off.
- (3) **Continue:** When pressing “Scan” key, turning on scanning light, No need to press the trigger then the scanner can read barcode when the LED light source is on.
- (4) **Toggle:** Scan Toggle label if you intend to gain more flexibility in when to read a barcode. A press on Scan Button will lead in switching on the light whereas either a successful decoding of a barcode or giving it another press correspondingly switches off the light. Please scan the appropriate label to determine your preferred scan mode.

 * B 8 0 8 0 * Good Read Off
 * B 8 0 8 1 * Momentary
 * B 8 0 8 2 * Continue
 * B 8 0 8 3 * Toggle



6-3-2 Output Interface

Please scan the appropriate barcode to specify the output interface

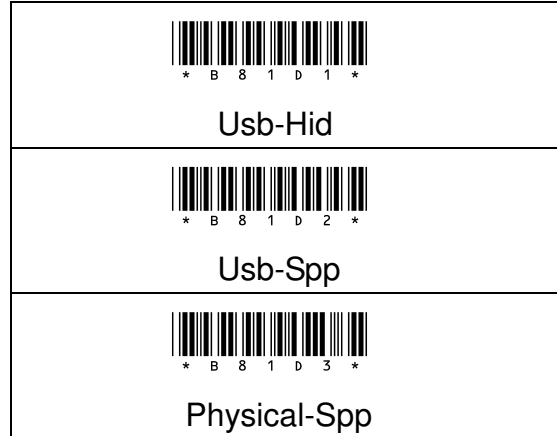

6-3-3 Scan Activation Time

In general, after Scan Button is pressed down, LED light will emit a stream of light for a scan attempt. This parameter is thus used to specify activation duration which indicates the amount of time LED light will stays on after Scan button is held.



Configuration Range	Unit	Default Setting
5 Secs ~ 4 Min 15 Secs	1 Secs	10 Secs

Procedure

- (A) Scan "Enter" barcode
- (B) Scan "Scan Activation Time" barcode
- (C) Scan parameters from Hexadecimal / Decimal table
- (D) Scan "OK" barcode
- (E) Scan "End" barcode

Enter



123

End



6-3-4 Composite Triggers Functionality

Some supplementary functions are necessarily executed by using composite triggers though Scan Button primarily serves to scan barcodes and Small Trigger to initiate data transmission. In Cable mode, battery charge is an extra function which can be initiated by pressing Small Trigger and Scan Button in a specified sequence described below: while holding Small Trigger till the green LED light starts flashing rapidly, press down Scan Button at the same time and then release both buttons. Scan the appropriate label to enable or disable functionality of battery charge.



6-3-5 Small Trigger Functionality

Small Trigger is designed to perform various supplementary operations, from initiating battery charge to switching to data transmission mode, according to the length of time the button has been pressed. To facilitate the associated operations with Small Trigger, this parameter is available to specify the degree of Small Trigger's functionality. Scan **Disable** label to specify Small Trigger will not provide any additional function. On the other hand, when **Mem Tx** is enabled, the device is able to switch to data transmission mode by keep holding Small Trigger till the blue LED as solid color, then release Small Trigger to into Transmit mode; at this moment, push Scan key will transmit the stored data.

By default, Small Trigger is set for maximum functionality without limit.



6-3-6 Battery Charge

Scan the appropriate barcode to determine whether to initiate battery charge whenever the device is well connected to host PC using an interface cable.

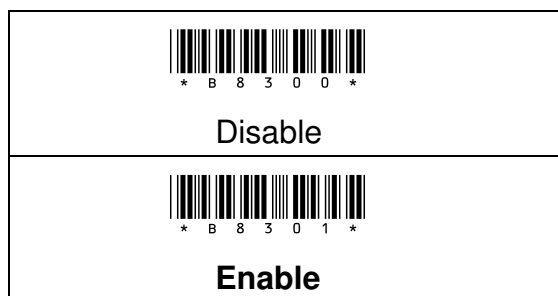

6-3-7 Power Saving Time

The device will switch to power-saving mode after remaining idle for a while. This parameter is thus used to specify the length of time allocated for the scanner to elapse before power-saving mode is initiated.



Configuration Range	Unit	Default Setting
0 Secs ~ 4 Min 15 Secs	1 Secs	3 Secs

- (A) Scan “Enter” barcode
- (B) Scan “Power Saving Time” barcode
- (C) Scan parameters from Hexadecimal / Decimal table
- (D) Scan “OK” barcode
- (E) Scan “End” barcode



6-3-8 Stand by Time

After lengthy idleness, the device will first be put into standby state in which the machine is still able to react to the emergent request yet running in lower power consumption. This parameter refers to the amount of time allocated for the device to stay in standby before being totally shut down.



Configuration Range	Unit	Default Setting
10 Sec ~ 4Min 15 Secs	1 Sec	10 Secs

Procedure	Example
(A) Scan "Enter" barcode (B) Scan "Stand by time" barcode (C) Scan parameters from Hexadecimal / Decimal table (D) Scan "OK" barcode (E) Scan "End" barcode	If configuration is 1 minutes, the parameter value is 1 min / 1 sec = 60

Enter



126



End





6-3-9 Date & Time Transmission

Under Cable mode, whether or not to transmit date or Time information.

Date:

 * B A 1 3 0 * Disable
 * B A 1 3 1 * Enable

Time:

 * B A 1 4 0 * Disable
 * B A 1 4 1 * Enable

6-3-10 Date & Time Delimiter

When the display is used to set the date and the time, date and time parameters parameter delimiter



Procedure

- (A) Scan "Enter" barcode
- (B) Scan "Date & Time Delimiter" barcode
- (C) Scan parameters from Hexadecimal / Decimal table
- (D) Scan "OK" barcode
- (E) Scan "End" barcode

Enter



127

End



6-3-11 Reject Same

User can configure the scanner to avoid reading the same barcode in sequent. This function is avoiding the scanner to read the same barcode by mistake.

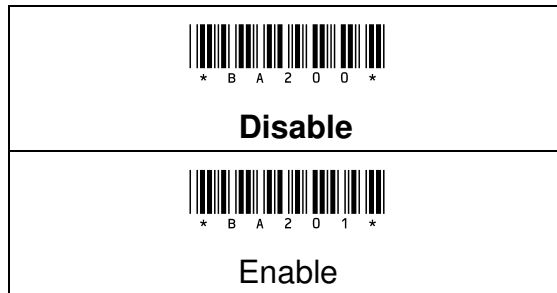

6-3-12 Good Read Beep

Scan the appropriate barcode to enable or disable Good Read Buzzer when a barcode is successfully decoded.

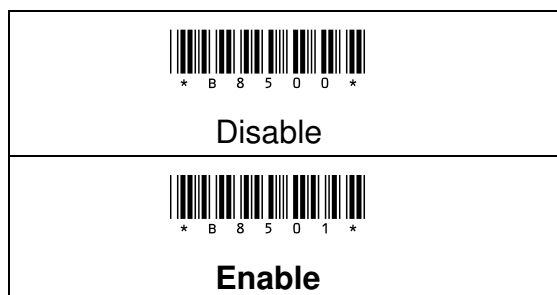

6-3-13 Warning Beep

Warning or error occurred, whether the sound of switch

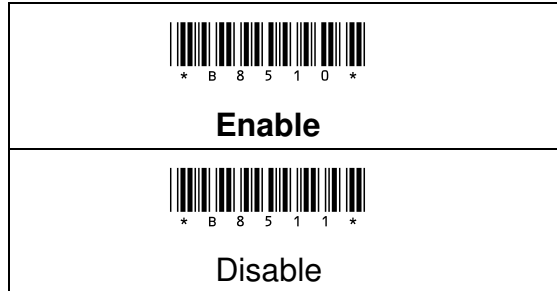

6-3-14 Normal Beep

When the mode switch is a switch will sound

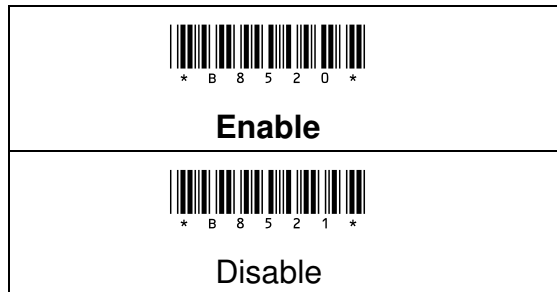

6-3-15 Good Read Vibrator

The vibration configuration if barcode reading is successfully decoded. **Note:** **Vibration function is only available with optional purchased Vibrator installed.**

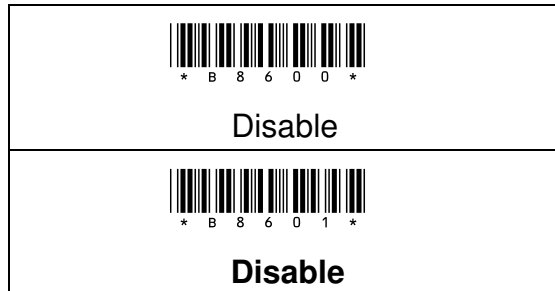

6-3-16 Warning Vibrator

Warning or error occurred, whether the Vibrator of switch

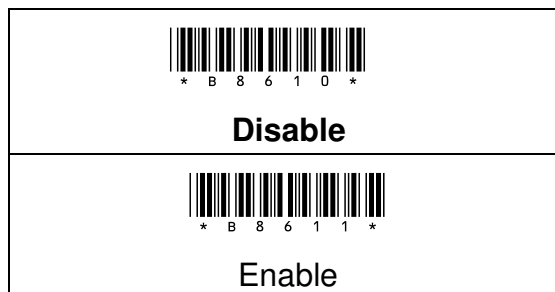

6-3-17 Normal Vibrator

Warning or error occurred, whether the Vibrator of switch

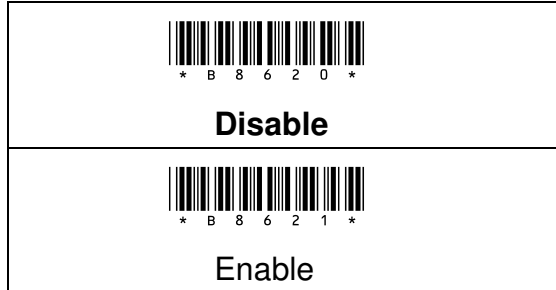

6-3-18 Viberator Time

Please follow the below steps to specify the length of time the device stays in a state of vibration when a barcode is decoded successfully



Configuration Range	Unit	Default Setting
0.02 Secs ~ 2.55 Secs	0.01 Sec	0.05 Secs

Procedure
(A) Scan "Enter" barcode (B) Scan "Viberator Time" barcode (C) Scan parameters from Hexadecimal / Decimal table (D) Scan "OK" barcode (E) Scan "End" barcode



6-3-19 Transmission Length

If user needs to know the length of the barcode data, this configuration enables to indicate the barcode length in front of barcode data.

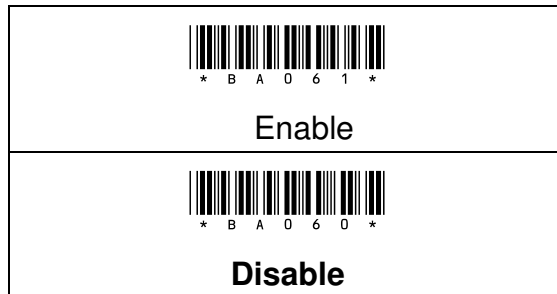

6-3-20 Force Case

This configuration enables to convert all output digits to be same printing-case; even one barcode may have two kinds of case

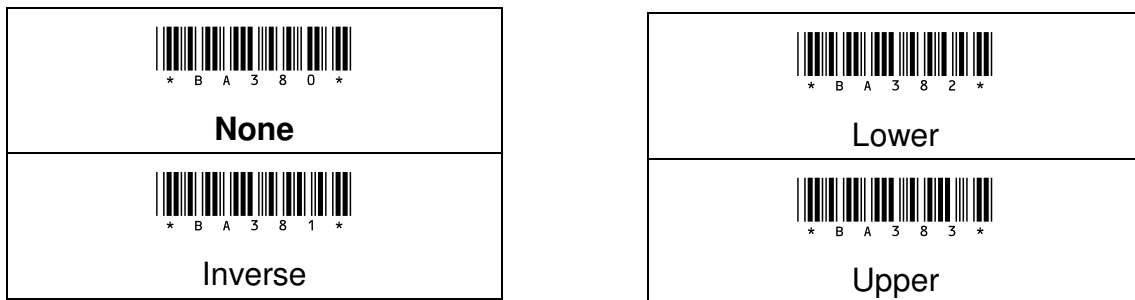

6-3-21 Transmission Code ID

When scanning the barcode, User might want to know the symbology of the barcode ID, This configuration enables to display the Code ID or Sub Code ID.

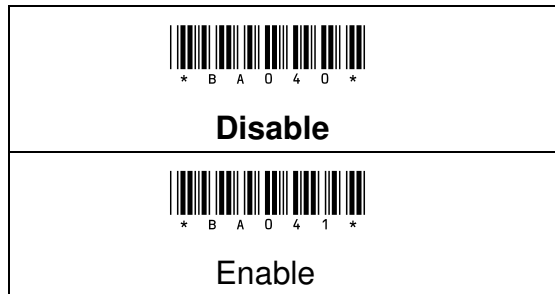



6-3-22 Code ID Position

When “Transmission Code ID” is “Enable”, user can configure the output position of Code ID or Sub Code ID (Before Barcode/ After Barcode).







6-3-23 Transmission Code Name

This configuration enables to show the barcode symbology name. Symbology name will be showing in front of barcode data.

 * B A 0 7 0 * Disable
 * B A 0 7 1 * Enable

6-3-24 GoodRead Volume





Beep volume configuration enables to configure the volume of the Beep sound

 * B 8 4 8 0 * Level1
 * B 8 4 8 1 * Level2
 * B 8 4 8 2 * Level3
 * B 8 4 8 3 * Level4



6-3-25 Warning Volume

Beep volume configuration enables to configure the volume of the Beep sound

 * B 8 4 9 0 *
Level1
 * B 8 4 9 1 *
Level2
 * B 8 4 9 2 *
Level3
 * B 8 4 9 3 *
Level4

Enter







135

End



6-3-26 Normal Volume

Scan the appropriate barcode to specify the volume of Normal Event Buzzer when certain operations, such as switching operation modes, entering data transmission mode, and deleting all saved barcodes, are initiated by using Scan Button or Small Trigger so that LED indicator accordingly changes its blinking frequency or color. The higher level indicates the louder sound.

 * B 8 4 A 0 *
Level1
 * B 8 4 A 1 *
Level2
 * B 8 4 A 2 *
Level3
 * B 8 4 A 3 *
Level4



6-3-27 Beep Tone

Beep Tone configuration enables to configure the frequency of beep sound.



Configuration Range	Unit	Default Setting
100 - 5000HZ	100 HZ	2700 HZ

Procedure:	Example:
(A) Scan "Enter" barcode (B) Scan "Beep Tone" barcode (C) Scan parameters from Hexadecimal / Decimal table (D) Scan "OK" barcode (E) Scan "End" barcode	If configuration is 3000 Hz, the parameter value is 3000Hz / 100 Hz = 30

6-3-28 Beep Time

Beep time configuration enables to configure the duration of the beep sound.



Configuration Range	Unit	Default Setting
0 ~ 2.5 Sec	0.01 sec	0.1 sec

Procedure:	Example:
(A) Scan "Enter" barcode (B) Scan "Beep Time" barcode (C) Scan parameters from Hexadecimal / Decimal table (D) Scan "OK" barcode (E) Scan "End" barcode	If configuration is 0.2 sec, the parameter value is 0.2 sec / 0.01 sec = 20

Enter



End



6-3-29 Double Confirm

This option enables the scanner to double confirm the barcode data, if this option is enabled, the scanner will require more times to verify the barcode data. This setting will related to the double confirm count configuration, the more confirm counts will inhibit miss-reading barcodes.

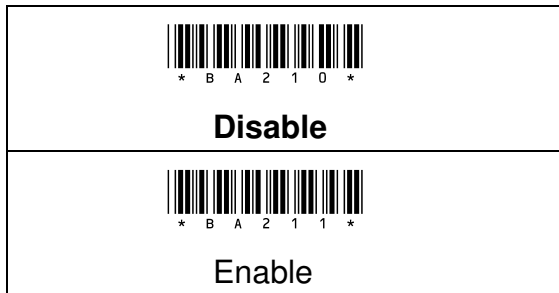

6-3-30 Date/Time Position

If you want to display data, you can use this function to set Date/Time position. Date and Time Transmission must be enabled and configure the following formats: (**chapter: 6-3-9**)



6-3-31 Preamble code

Preamble Code refers to a sequence of characters which precedes both Prefix Code and barcode data during data transmission. Scan the appropriate barcode to enable or disable Preamble Code.

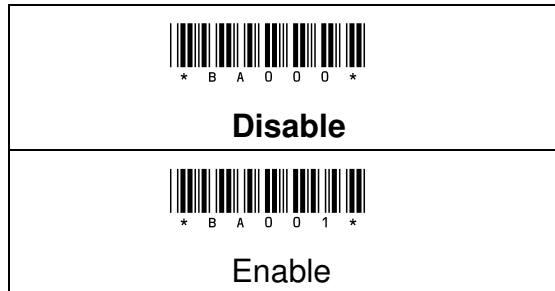

6-3-32 Preamble Content

Setting Preamble code content



Procedure
(A) Scan "Enter" barcode (B) Scan "Preamble Content" barcode (C) Scan parameters from Hexadecimal / Decimal table (D) Scan "OK" barcode (E) Scan "End" barcode

Enter



139

End



6-3-33 Postamble Code

Postamble Code refers to a sequence of characters which appends to both barcode data and Suffix Code during data transmission. Scan the appropriate barcode to enable or disable Postamble Code.

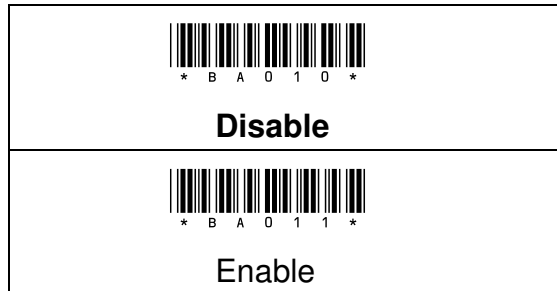

6-3-34 Postamble Content

Setting Postamble code content



Procedure

- (A) Scan "Enter" barcode
- (B) Scan "Postamble Content" barcode
- (C) Scan parameters from Hexadecimal / Decimal table
- (D) Scan "OK" barcode
- (E) Scan "End" barcode

Enter



140

End



6-3-35 Prefix Code

Prefix Code is a sequence of characters interposed between Preamble Code and barcode data during data transmission. Scan the appropriate barcode to enable or disable Prefix Code

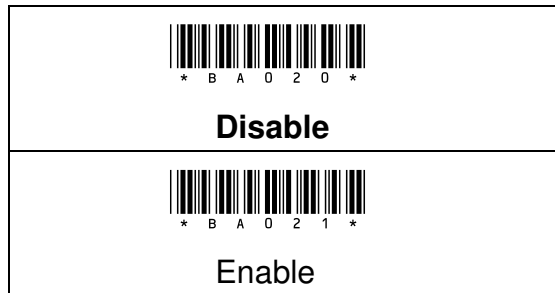

6-3-36 Prefix Content

Setting Prefix code content



Procedure

- (A) Scan "Enter" barcode
- (B) Scan "Prefix Content" barcode
- (C) Scan parameters from Hexadecimal / Decimal table
- (D) Scan "OK" barcode
- (E) Scan "End" barcode

Enter



141

End



6-3-37 Suffix Code

Suffix Code is a sequence of characters interposed between barcode data and Postamble Code during data transmission. Scan the appropriate barcode to enable or disable Suffix Code.

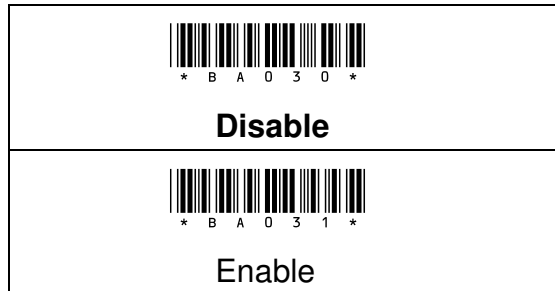

6-3-38 Suffix Content

Setting Suffix code content



Procedure

- (A) Scan "Enter" barcode
- (B) Scan "Suffix Content" barcode
- (C) Scan parameters from Hexadecimal / Decimal table
- (D) Scan "OK" barcode
- (E) Scan "End" barcode



6-3-39 Control Characters

Scan the appropriate barcode to determine whether or not to transmit control code info along with the decoded message if the scanned barcode contains the special ASCII code.

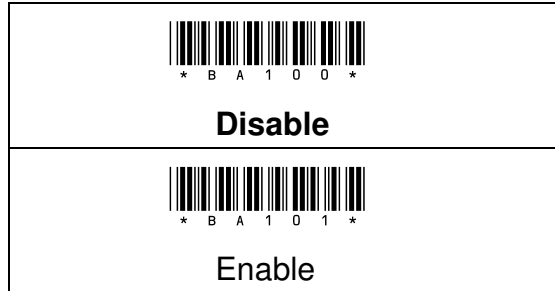

6-3-40 Delimiter code

Scan the appropriate barcode to determine whether or not to interpose the delimiter parameter between the decoded message and timestamps.

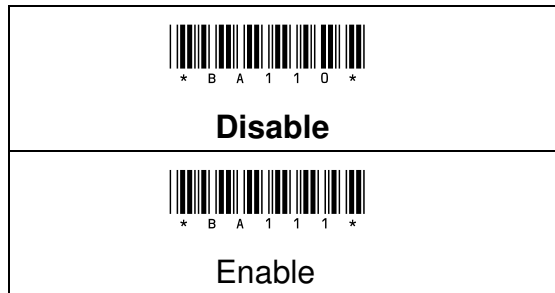

6-3-41 Delimiter Content

If user want to delimit datetime & barcode. Please scan below barcode to setting.



Procedure

- (A) Scan "Enter" barcode
- (B) Scan "Delimiter Content" barcode
- (C) Scan parameters from Hexadecimal / Decimal table
- (D) Scan "OK" barcode
- (E) Scan "End" barcode

Enter



144

End



6-4 Scanner Configuration by Software

6-4-1 Firmware Update

Open the software "Barcode Scanner Setting", the file is located in the CD (CM-520\Software\Normal command setting\Scanner Setting.exe)

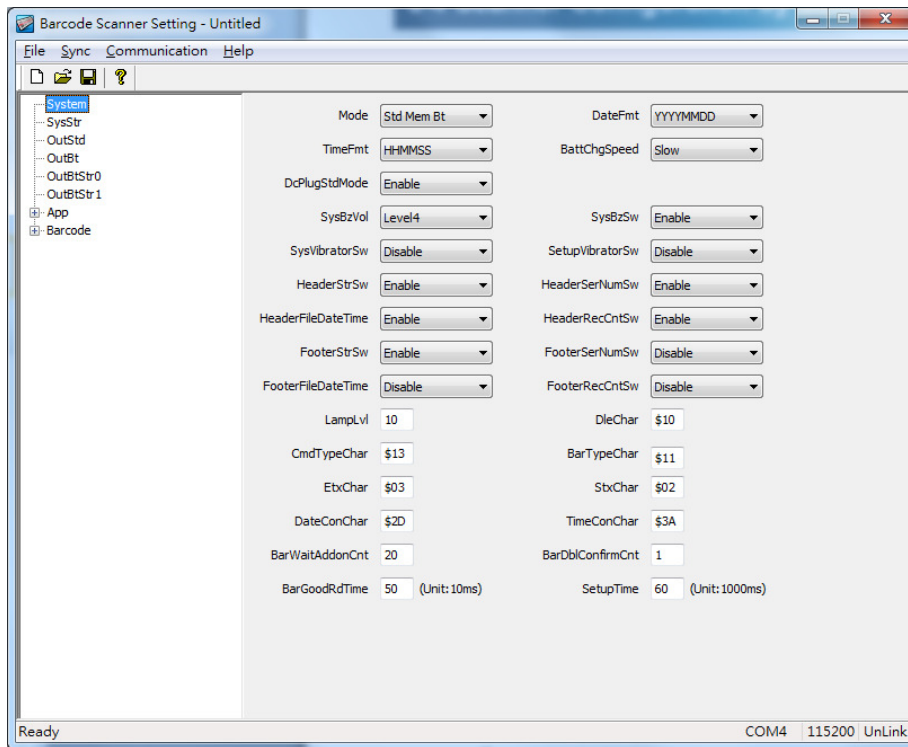

Connect scanner with PC by USB cable, and set the scanner to ISP mode.
Scan below barcodes to set the scanner to ISP mode.

1. ENTER: 

2. ISP: 

Note: ISP mode means scanner configuration mode.

Before any configuration with the software, scanner must scan above two barcodes in order to perform software configuration.

Enter



145

End



- When the scanner is in ISP mode, the PC might request for driver installation, **the driver is located in the CD (CM-520\driver\C0801b.inf).**

After the scanner scan Enter. ISP barcode, the “green” LED indicator will be flashing, then proceed to “Device Manager” to check COM Port

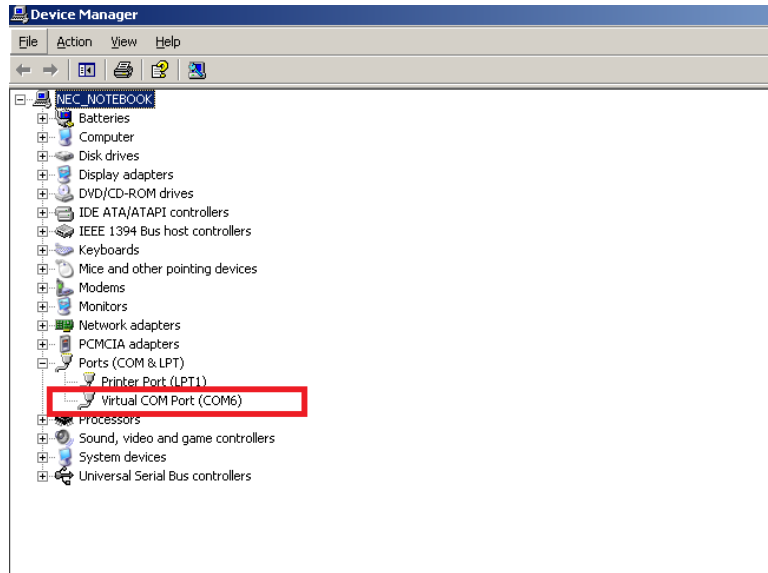

For example: The COM Port used by scanner is COM6

In barcode scanner setting software, **Sync → Properties**

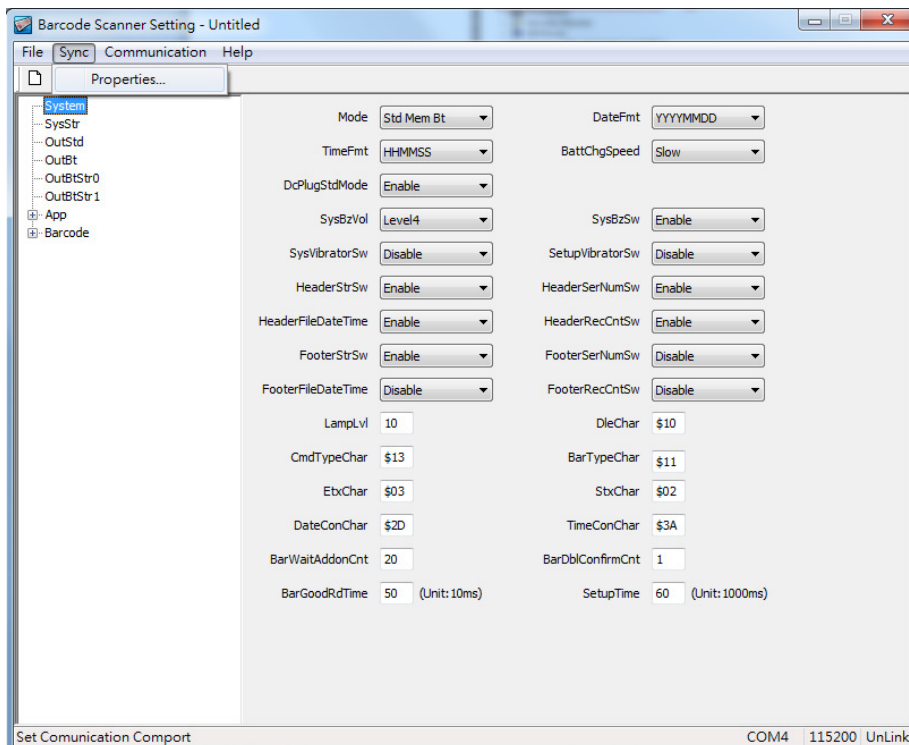

And select the COM port (for example:COM6, Note: Baud rate is 115200)

Enter

146

End



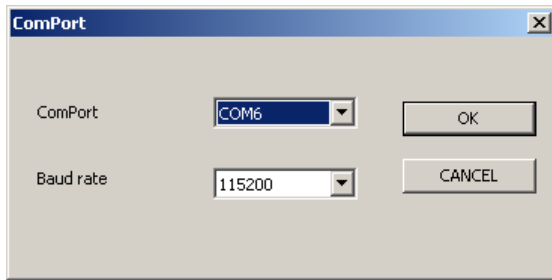

Select "OK" for software synchronization.

Under "Communication → Download Kernel File"

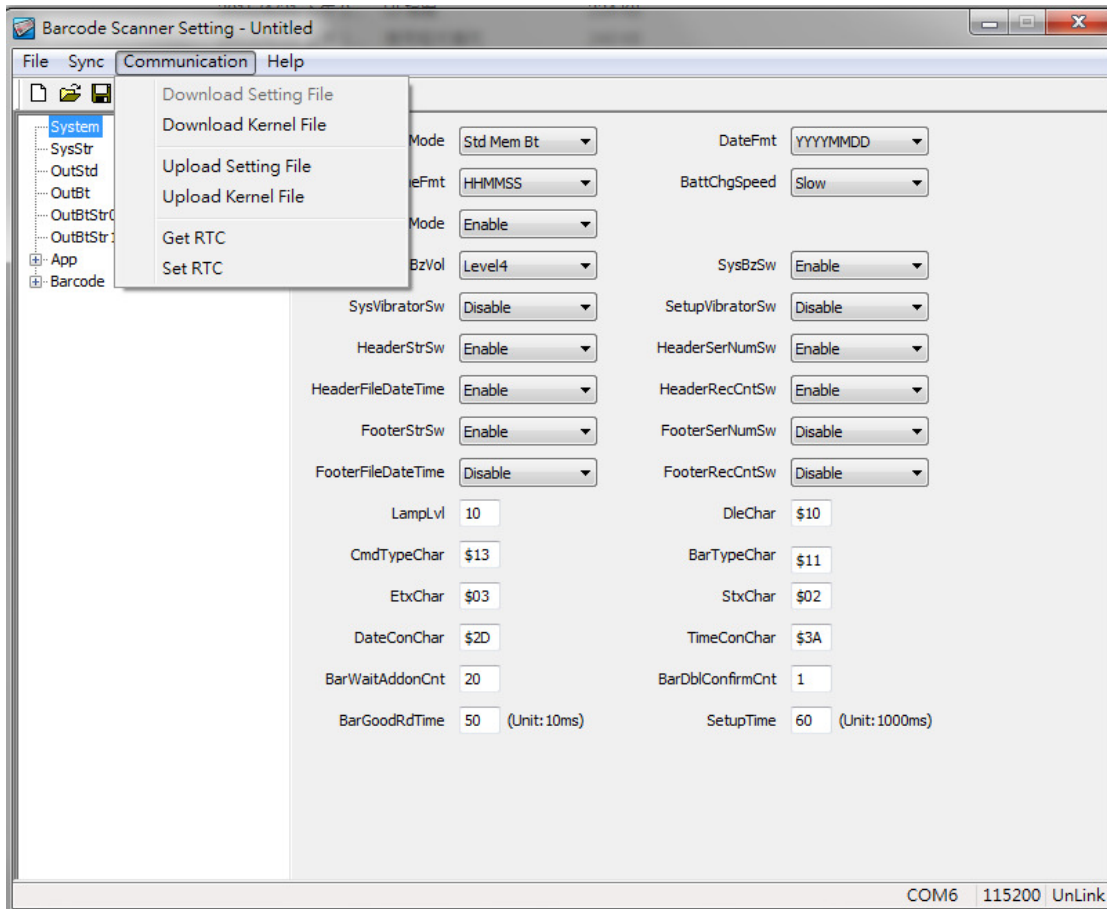

Select the kernel file (for example: 0002-0008.Bin)

Enter



147

End



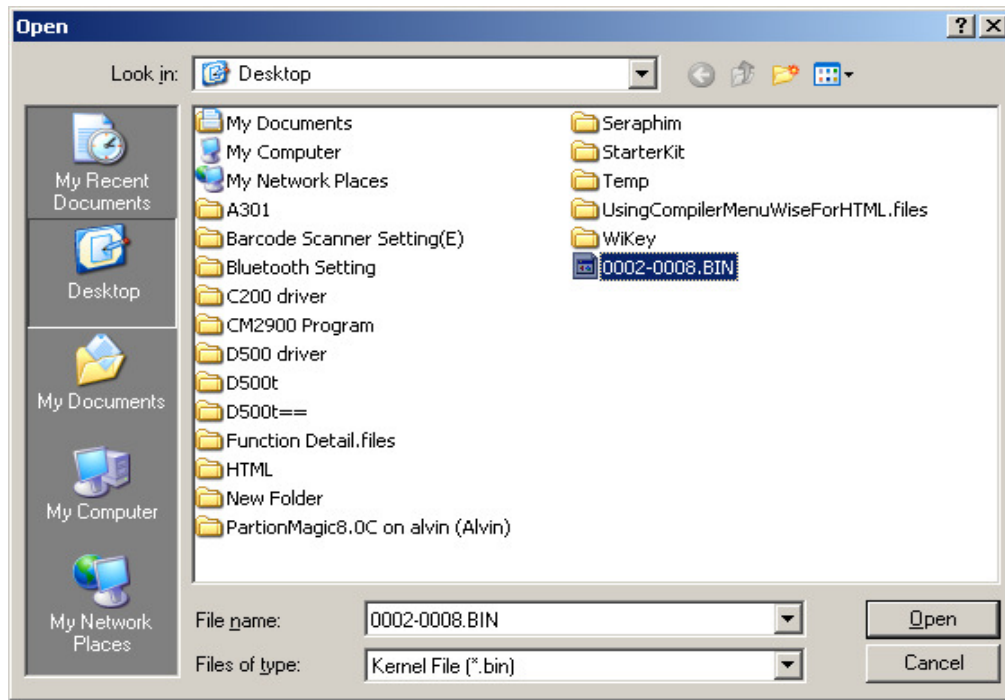

Select "Open" for firmware update



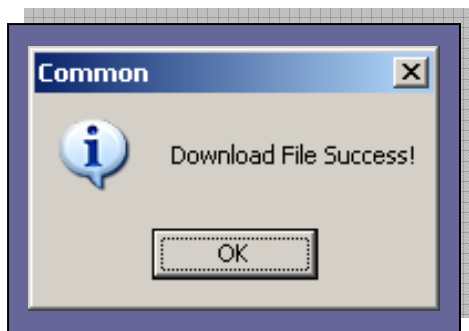
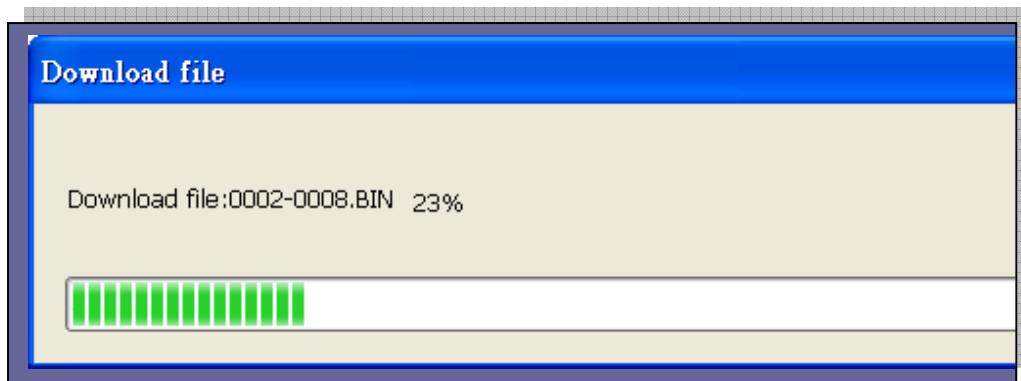

After firmware updated, please exit the software. The scanner will reboot.



6-4-2 Scanner Configuration

Open software "Barcode Scanner Setting", the file is located in the CD
(CM-520\Software\Normal command setting\Scanner Setting.exe)

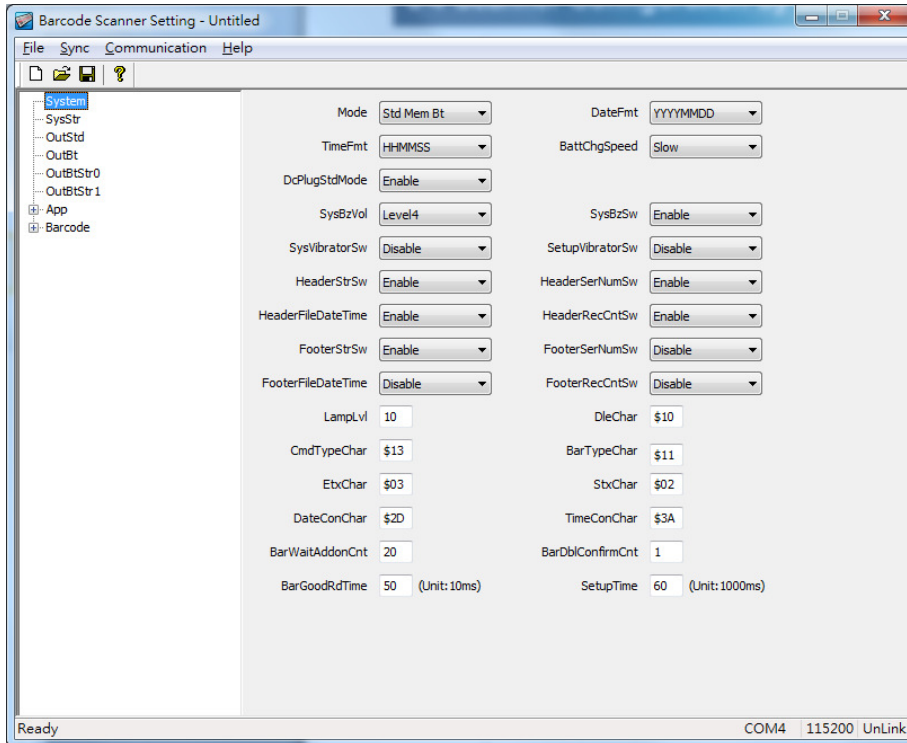

Connect scanner with PC by USB cable, and Set the scanner to ISP mode.
Scan below barcodes step by step to set the scanner to ISP mode.

1. ENTER: 

2. ISP: 

Note: ISP mode means scanner configuration mode.

Before any configuration with the software, scanner must scan above two barcodes in order to perform software configuration.

- When the scanner is in ISP mode, the PC might request for driver installation, **the driver is located in the CD (CM-520\driver\C0801b.inf).**

Enter



150

End



After the scanner scan Enter. ISP barcode, the “green” LED indicator will be flashing, then proceed to “Device Manager” to check COM Port



For example: The COM Port used by scanner is COM6

In barcode scanner setting software, **Sync** → **Properties**

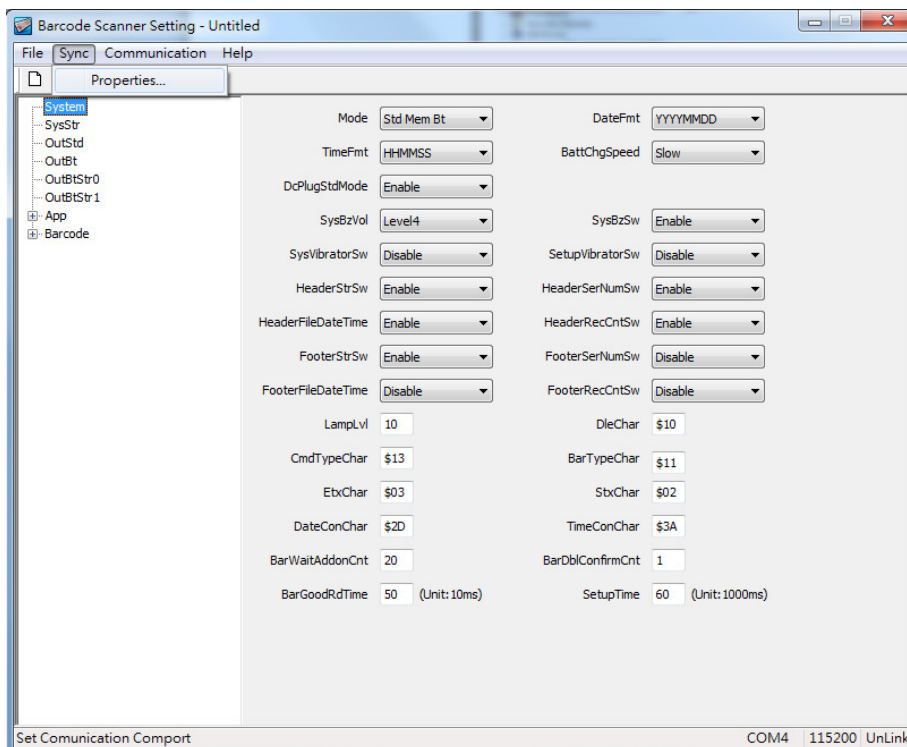

And select the COM port (for example:COM6, Note: Baud rate is 115200)

Enter



151

End



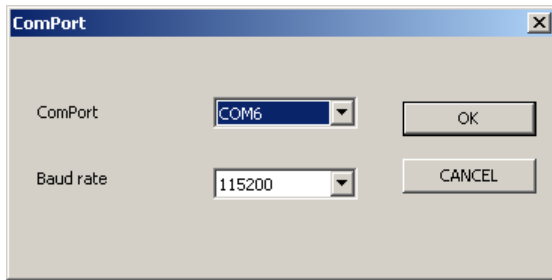

Select "OK" for software synchronization.

User can change the settings of scanner (For example, enable Interleaved 2 of 5)

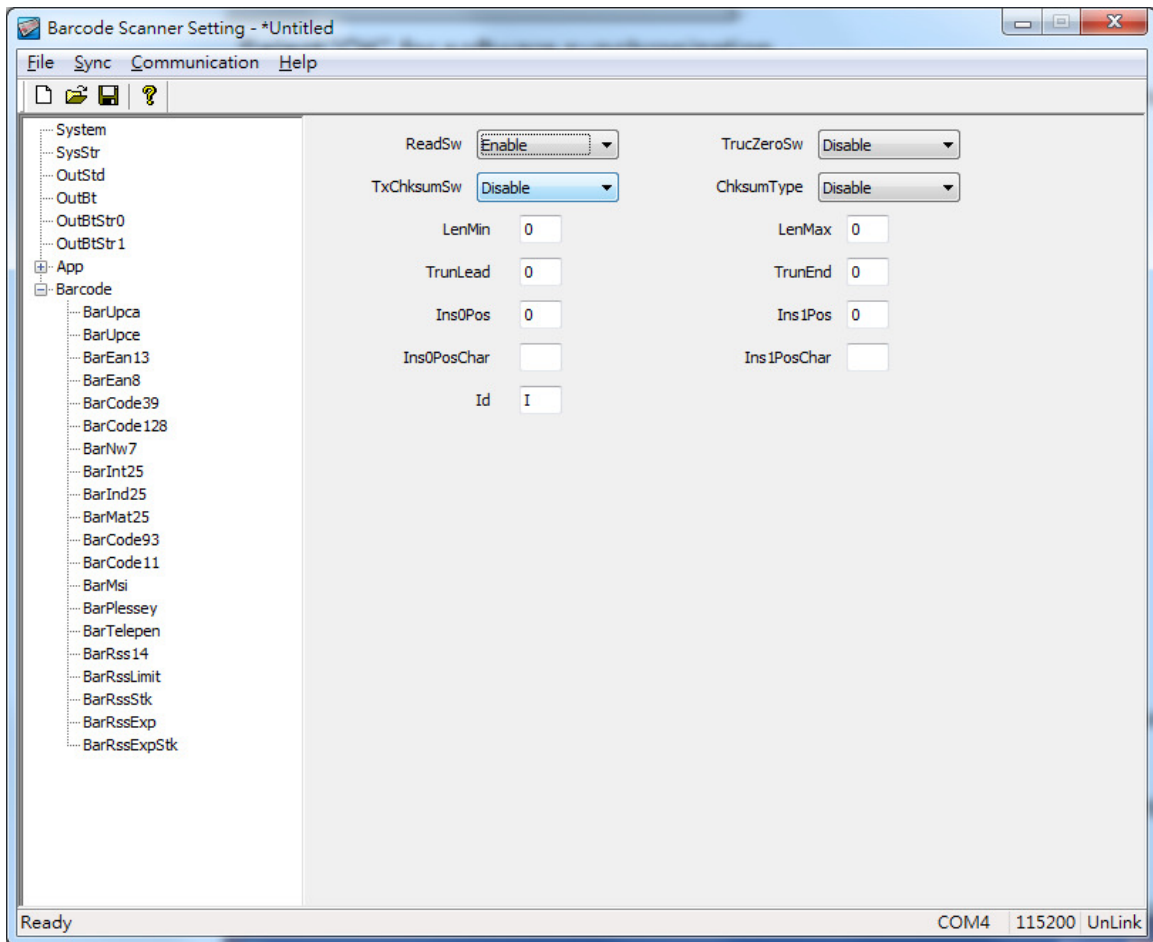

Save the "configure content" and specified a file name in your local drive.

Enter



152

End



Under communication → Download Setting File”, the settings will download to the scanner.

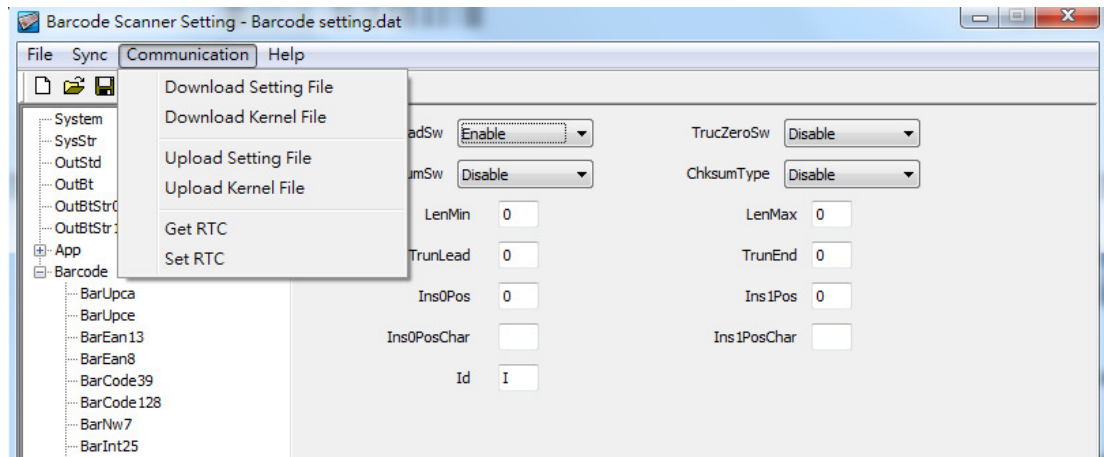

Exit the software will exit the barcode scanner setting configuration and scanner will reboot.

Note: For detail configuration, please refer to additional manual “barcode scanner user manual”(CM-520\Manuals\ User manual for setting software on wireless barcode scanner.pdf)



Chapter 7: General configuration setting

General configuration setting

7-1 Host Interface

- 7-1-1 Version
- 7-1-2 Abort Setting
- 7-1-3 ISP Mode
- 7-1-4 Barcode Default
- 7-1-5 All Default
- 7-1-6 Mode Switch

7-2 Output Interface

Cable

7-2-1 USB-HID Keyboard Type

- 7-2-1-1 Caps Lock
- 7-2-1-2 Num Lock
- 7-2-1-3 Caps Lock Emulation
- 7-2-1-4 Set OS
- 7-2-1-5 Transmission specific symbols Delay Time
- 7-2-1-6 Transmission Timeout
- 7-2-1-7 Transmission Char Delay
- 7-2-1-8 Transmission Char Gap Time
- 7-2-1-9 Transmission Record Gap Time
- 7-2-1-10 USB HID Layout Setting

7-2-2 USB-SPP(Virtual COM) Type

- 7-2-2-1 Length of Data Transfer Bit
- 7-2-2-2 Length of Data Stop Bit
- 7-2-2-3 Parity Check
- 7-2-2-4 Communication Protocol
- 7-2-2-5 <STX> & <ETX> Characters
- 7-2-2-6 <CMD> & <BAR> Characters
- 7-2-2-7 Command Mode
- 7-2-2-8 Baud Rate
- 7-2-2-9 Retransmission Count
- 7-2-2-10 ACK Timeout
- 7-2-2-11 Transmission specific symbols Delay Time



- 7-2-2-12 Transmission Timeout
- 7-2-2-13 Transmission Char Delay
- 7-2-2-14 Transmission Char Gap Time
- 7-2-2-15 Transmission Record Delay

Bluetooth Mode

7-2-3 Bluetooth-HID Type

- 7-2-3-1 Caps Lock
- 7-2-3-2 Num Lock
- 7-2-3-3 Bluetooth HID Layout Setting
- 7-2-3-4 Transmission specific symbols Delay Time
- 7-2-3-5 Transmission Timeout
- 7-2-3-6 Transmission Char Delay
- 7-2-3-7 Transmission Char Gap Time
- 7-2-3-8 Transmission Record Gap Time

7-2-4 Bluetooth-SPP Type

- 7-2-4-1 Communication Protocol
- 7-2-4-2 <STX> & <ETX> Characters
- 7-2-4-3 <CMD> & <BAR> Characters
- 7-2-4-4 Command Mode
- 7-2-4-5 Retransmission Count
- 7-2-4-6 ACK Timeout
- 7-2-4-7 Transmission specific symbols Delay Time
- 7-2-4-8 Transmission Timeout
- 7-2-4-9 Transmission Char Delay
- 7-2-4-10 Transmission Char Gap Time
- 7-2-4-11 Transmission Record Gap Time

7-3 System Control

7-3-1 Mode

7-3-2 System Beep Sw

7-3-3 Date Format

7-3-4 Time Format

7-3-5 Battery Charge Speed

7-3-6 USB Plug to Cable Mode

7-3-7 System Beep Volume

7-3-8 System Vibrator

7-3-9 Setup Vibrator

7-3-10 Header Str Sw

Enter



155

End



- 7-3-11 Header Serial Number
- 7-3-12 Header Date & Time
- 7-3-13 Header Record Count
- 7-3-14 Footer Str Sw
- 7-3-15 Footer Serial Number
- 7-3-16 Footer Date & Time
- 7-3-17 Footer Record Count
- 7-3-28 Lamp Light Brightness
- 7-3-19 DLE Escape Characters
- 7-3-20 CMD Escape Characters
- 7-3-21 BAR Escape Characters
- 7-3-22 ETX Escape Characters
- 7-3-23 STX Escape Characters
- 7-3-24 Date Separator
- 7-3-25 Time Separator
- 7-3-26 Wait Addon Count
- 7-3-27 Double Confirm Count
- 7-3-28 Continue Mode Clear Time
- 7-3-29 Setup Time
- 7-3-30 Set Date & Time Format
- 7-3-31 All Memory Data Clear
- 7-3-32 All Data Transmission
- 7-3-33 Footer Chatacters
- 7-3-34 Header Chatacters

Note: It is recommended to print out the Hexadecimal / Decimal table (page: 315) for parameter setting.



7. General Configuration Setting

7-1 Host Interface

7-1-1 Version

Firmware information listing, the scanner firmware information included the firmware family, the firmware version and Bluetooth module version (if scanner Bluetooth function is available).



Procedure:

- (1) Scan "Enter" Barcode
- (2) Scan "Version" barcode

Note: Firmware version listing as below

Mode: Normal	→ Scanner version(Normal or SunShine)
Isp: 0001.0001	→ ISP version
Kernel: 0001.0012	→ Firmware version
Bt: V100-T028BT-20111027	→ Bluetooth module version (this is only available for Bluetooth model).
Mac: 001C975096E6	→ Bluetooth module Mac Address

7-1-2 Abort Setting

To skip or cancel current operation, your current settings will be aborted before you scan "END" barcode to finish programming.



Scan "Abort" Barcode to cancel the setting before you scan "END" barcode



7-1-3 ISP Mode

For software configuration, User must connect the scanner with PC via USB cable, and scan "Enter ", "ISP" to enter the ISP mode. (PC might request for Driver installation, please find the driver file "C0801b.inf " in the CD)



7-1-4 Barcode Default

Scan the below barcode to restore the symbologies to the default settings.



7-1-5 All Default

Configuration setting to restored to factory default setting.



Enter



158

End



7-1-6 Mode Switch

After reading **ENTER** label, scan the below appropriate barcode to switch to the desired operation mode.

To Cable Mode



To Memory Mode



To BT Mode



Enter



159

End



7- 2 Output Interface

Cable Mode

User can connect the scanner with PC via USB cable to upload the saved barcode data, or it can be used as real time USB scanner.

There are two different output Interfaces:

- (1) **USB-HID (Keyboard) Type:** With USB HID type, user can use Word, Excel or any word processing software to receive barcode data.
- (2) **USB-SPP (Virtual Com) Type:** With USB- COM type, user need to use terminal software to receive the barcode data.



7-2-1 USB-HID Keyboard Type

7-2-1-1 Caps lock

Caps lock setting for the barcode data display.

 * A B 0 A 0 * Auto
 * A B 0 A 3 * Alt
 * A B 0 A 1 * Caps lock off
 * A B 0 A 2 * Caps lock On

Note: When BT mode, "Auto" no work

Example Barcode data "ABCdef"

Status Selection	Caps Lock On	Caps Lock Off
Caps Lock On	ABCdef	abcDEF
Caps Lock Off	abcDEF	ABCdef
Alt+Keypad	ABCdef	ABCdef



7-2-1-2 Num Lock

The settings of the numeric keypad, the keypad must be selected if the application program only accepts numeric keypad. (The right hand side of the numeric keys on the keyboard, and “NumLock” control key must be on.)



7-2-1-3 Shift Release Caps Lock

Scan the following barcode can let the user to press “Shift” to release the status of Caps Lock.

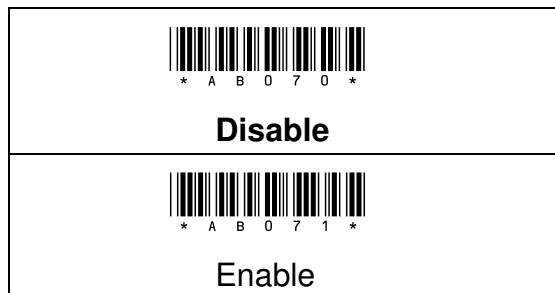

7-2-1-4 Set OS

Set the OS operating environment

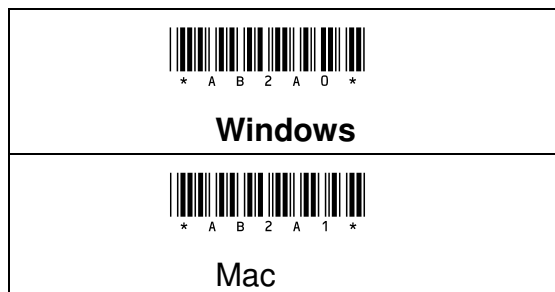

7-2-1-5 Transmission specific symbols Delay Time

Delay time after transmitting specific symbols



Configuration Range	Unit	Default Setting
0 ~ 2.5 sec	0.01 sec	0

Procedure:	Example:
(A) Scan "Enter" barcode (B) Scan "Transmission specific symbols Delay" barcode (C) Scan parameters from Hexadecimal / Decimal table (D) Scan "OK" barcode (E) Scan "End" barcode	If configuration is 0.02 sec, the parameter value is 0.02 sec / 0.01 sec = 2

7-2-1-6 Transmission Timeout

After sending the information, how long time did not respond will start timeout



Configuration Range	Unit	Default Setting
2 ~ 255 sec	1 sec	3

Procedure:	Example:
(A) Scan "Enter" barcode (B) Scan Transmission Timeout barcode (C) Scan parameters from Hexadecimal / Decimal table (D) Scan "OK" barcode (E) Scan "End" barcode	If configuration is 2 sec, the parameter value is 2 sec / 1 sec = 2



7-2-1-7 Transmission Char Delay

After setting the number of characters transmitted into the Delay Time



Procedure

- (A) Scan "Enter" barcode
- (B) Scan "Transmission Char Delay" barcode
- (C) Scan parameters from Hexadecimal / Decimal table
- (D) Scan "OK" barcode
- (E) Scan "End" barcode

7-2-1-8 Transmission Char Gap Time

Time after sending characters to be sent the next character



Configuration Range	Unit	Default Setting
0 ~ 0.25 sec	0.001sec	0.002 sec

Procedure:	Example:
(A) Scan "Enter" barcode (B) Scan Transmission Timeout barcode (C) Scan parameters from Hexadecimal / Decimal table (D) Scan "OK" barcode (E) Scan "End" barcode	If configuration is 0.002 sec, the parameter value is 0.002 sec / 0.001 sec = 2

Enter



End



7-2-1-9 Transmission Record Gap Time

This function can set Delay Time between 2 records.



Configuration Range	Unit	Default Setting
0~2.5 sec	0.01sec	0

Procedure:	Example:
(A) Scan "Enter" barcode (B) Scan Transmission Timeout barcode (C) Scan parameters from Hexadecimal / Decimal table (D) Scan "OK" barcode (E) Scan "End" barcode	If configuration is 0.2 sec, the parameter value is 0.2 sec / 0.01 sec = 20

7-2-1-10 USB HID Layout Setting

The function enables the user to specify HID keyboard language.







HID Keyboard Layout setting
<p>* A B 1 C 0 *</p> <p>EN</p>
<p>* A B 1 C 1 *</p> <p>UK</p>
<p>* A B 1 C 2 *</p> <p>JP</p>
<p>* A B 1 C 3 *</p> <p>FR</p>
<p>* A B 1 C 4 *</p>

Enter



End



GR
 * A B 1 C 5 *
IT
 * A B 1 C 6 *
SP
 * A B 1 C 7 *
PO
 * A B 1 C 8 *
SK
 * A B 1 C 9 *
KO
 * A B 1 C A *
Tr



7-2-2 USB-SPP (Virtual COM) Type

7-2-2-1 Length of Data Transfer Bit

Set the data bit length

 * A A 0 2 0 *
7bits
 * A A 0 2 1 *
8bits

7-2-2-2 Length of Data Stop Bit

 * A A 0 3 0 *
1bit
 * A A 0 3 1 *
2bits

Set the data stop bit length

Enter



167

End





7-2-2-3 Parity Check

Parity checking employs parity bits to detect whether an error occurs or not during data transmission.

 * A A 0 D 0 *
None
 * A A 0 D 1 *
Even
 * A A 0 D 2 *
Odd
 * A A 0 D 3 *
Space
 * A A 0 D 4 *
Mark

7-2-2-4 Communication Protocol

Scan the appropriate barcode to specify the communication protocol for SPP.

 * A A 1 C 0 *
None
 * A A 1 C 1 *
0x06/0x15
 * A A 1 C 2 *
"Ack"/"Nak"

Enter



End



7-2-2-5 <STX> & <ETX> Characters

Scan below barcodes to set if need to add STX data(before the output barcode data) & ETX data(after the output barcode data)



7-2-2-6 <CMD> & <BAR> Characters

Scan the appropriate barcode to enable or disable <BAR> and <CMD> escape characters

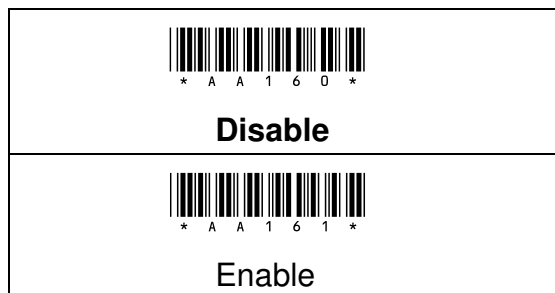





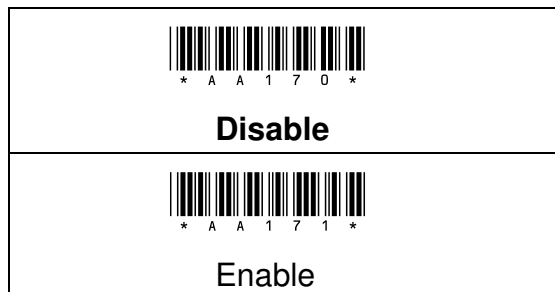





7-2-2-7 Command Mode

Scan the appropriate barcode to enable or disable Command mode for SPP.



7-2-2-8 Baud Rate

 * A A 2 C 0 * 300bps
 * A A 2 C 1 * 600bps
 * A A 2 C 2 * 1200bps
 * A A 2 C 3 * 2400bps
 * A A 2 C 4 * 4800bps
 * A A 2 C 5 * 9600bps
 * A A 2 C 6 * 19200bps
 * A A 2 C 7 * 38400bps
 * A A 2 C 8 * 57600bps
 * A A 2 C 9 * 115200bps
 * A A 2 C A * 230400bps

Enter



170

End





7-2-2-9 Retransmission Count

To avoid data transmission loss, messages sometimes have to be resent due to a failure to receive ACK signal.



Procedure:

- (A) Scan "Enter" barcode
- (B) Scan Transmission Timeout barcode
- (C) Scan parameters from Hexadecimal / Decimal table
- (D) Scan "OK" barcode
- (E) Scan "End" barcode

Enter



171

End



7-2-2-10 ACK Timeout

When the data set sent, how long shall receive ACK



Configuration Range	Unit	Default Setting
2 ~ 255 sec	1 sec	3

Procedure:	Example:
(A) Scan "Enter" barcode (B) Scan Transmission Timeout barcode (C) Scan parameters from Hexadecimal / Decimal table (D) Scan "OK" barcode (E) Scan "End" barcode	If configuration is.2 sec, the parameter value is 2 sec / 1 sec = 2



7-2-2-11 Transmission specific symbols Delay Time

Delay time after transmitting specific symbols



Configuration Range	Unit	Default Setting
0 ~ 2.5 sec	0.01 sec	0

Procedure:	Example:
(A) Scan "Enter" barcode (B) Scan "Transmission specific symbols Delay" barcode (C) Scan parameters from Hexadecimal / Decimal table (D) Scan "OK" barcode (E) Scan "End" barcode	If configuration is 0.02 sec, the parameter value is 0.02 sec / 0.01 sec = 2

7-2-2-12 Transmission Timeout

After sending the information, how long time did not respond will start timeout



Configuration Range	Unit	Default Setting
2 ~ 255 sec	1 sec	3

Procedure:	Example:
(A) Scan "Enter" barcode (B) Scan Transmission Timeout barcode (C) Scan parameters from Hexadecimal / Decimal table (D) Scan "OK" barcode (E) Scan "End" barcode	If configuration is .2 sec, the parameter value is 2 sec / 1 sec = 2

Enter



End



7-2-2-13 Transmission Char Delay

After setting the number of characters transmitted into the Delay Time



Procedure

- (A) Scan "Enter" barcode
- (B) Scan "Transmission Char Delay" barcode
- (C) Scan parameters from Hexadecimal / Decimal table
- (D) Scan "OK" barcode
- (E) Scan "End" barcode

7-2-2-14 Transmission Char Gap Time

Time after sending characters to be sent the next character



Configuration Range	Unit	Default Setting
0 ~ 0.25 sec	0.001sec	0.002 sec

Procedure:	Example:
<ul style="list-style-type: none"> (A) Scan "Enter" barcode (B) Scan Transmission Timeout barcode (C) Scan parameters from Hexadecimal / Decimal table (D) Scan "OK" barcode (E) Scan "End" barcode 	<p>If configuration is 0.002 sec, the parameter value is 0.002 sec / 0.001 sec = 2</p>

Enter



End



7-2-2-15 Transmission Record Delay

This function can set Delay Time between 2 records.



Configuration Range	Unit	Default Setting
0~2.5 sec	0.01sec	0

Procedure:	Example:
(A) Scan "Enter" barcode (B) Scan Transmission Timeout barcode (C) Scan parameters from Hexadecimal / Decimal table (D) Scan "OK" barcode (E) Scan "End" barcode	If configuration is 0.2 sec, the parameter value is 0.2 sec / 0.01 sec = 20

Enter



End



Bluetooth Mode

7-2-3 Bluetooth HID Type

7-2-3-1 Caps Lock

Caps lock setting for the barcode data display.

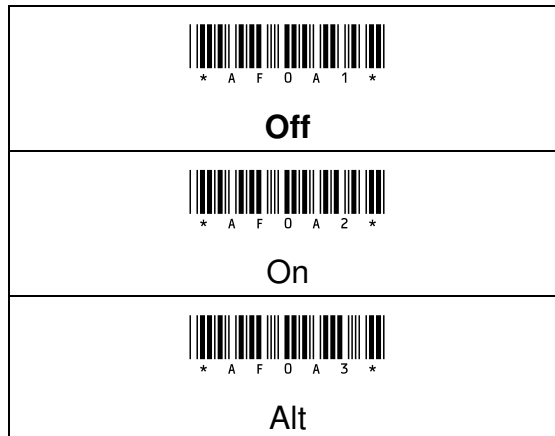











7-2-3-2 Num Lock

The settings of the numeric keypad, the keypad must be selected if the application program only accepts numeric keypad. (The right hand side of the numeric keys on the keyboard, and “NumLock” control key must be on.)



7-2-3-3 Bluetooth HID Layout Setting

Bluetooth HID Layout setting
 * A F 1 C 0 *
EN
 * A F 1 C 1 *
UK
 * A F 1 C 2 *
JP
 * A F 1 C 3 *
FR
 * A F 1 C 4 *
GR
 * A F 1 C 5 *
IT
 * A F 1 C 6 *
SP
 * A F 1 C 7 *
PO
 * A F 1 C 8 *
SK
 * A F 1 C 9 *
KO
 * A F 1 C A *
Tr

Enter



177

End



7-2-3-4 Transmission specific symbols Delay Time

Delay time after transmitting specific symbols



Configuration Range	Unit	Default Setting
0 ~ 2.5 sec	0.01 sec	0

Procedure:	Example:
(A) Scan “Enter” barcode (B) Scan “Transmission specific symbols Delay” barcode (C) Scan parameters from Hexadecimal / Decimal table (D) Scan “OK” barcode (E) Scan “End” barcode	If configuration is 0.02 sec, the parameter value is 0.02 sec / 0.01 sec = 2

7-2-3-5 Transmission Timeout

After sending the information, how long time did not respond will start timeout



Configuration Range	Unit	Default Setting
2 ~ 255 sec	1 sec	3

Procedure:	Example:
(A) Scan “Enter” barcode (B) Scan Transmission Timeout barcode (C) Scan parameters from Hexadecimal / Decimal table (D) Scan “OK” barcode (E) Scan “End” barcode	If configuration is 2 sec, the parameter value is 2 sec / 1 sec = 2



7-2-3-6 Transmission Char Delay

After setting the number of characters sent into the Delay time



Procedure
(A) Scan "Enter" barcode
(B) Scan "Transmission Char Delay" barcode
(C) Scan parameters from Hexadecimal / Decimal table
(D) Scan "OK" barcode
(E) Scan "End" barcode

7-2-3-7 Transmission Char Gap Time

Time after sending characters to be sent the next character.



Configuration Range	Unit	Default Setting
0.002 ~ 0.25 sec	0.001sec	2

Procedure:	Example:
(A) Scan "Enter" barcode (B) Scan "Transmission Char Gap Time" (C) Scan parameters from Hexadecimal / Decimal table (D) Scan "OK" barcode (E) Scan "End" barcode	If configuration is .2 sec, the parameter value is 2 sec / 1 sec = 2



7-2-3-8 Transmission Record Gap Time

This function can set Delay Time between 2 records.



Configuration Range	Unit	Default Setting
0~2.5 sec	0.01sec	0



Procedure:	Example:
(A) Scan "Enter" barcode (B) Scan "Transmission Record Gap Time" barcode (C) Scan parameters from Hexadecimal / Decimal table (D) Scan "OK" barcode (E) Scan "End" barcode	If configuration is 0.2 sec, the parameter value is 0.2 sec / 0.01 sec = 20



7-2-4 Bluetooth-SPP Type

7-2-4-1 Communication Protocol

Scan the appropriate barcode to specify the communication protocol for SPP.

 * A E 1 C 0 * None
 * A E 1 C 1 * 0x06/0x15
 * A E 1 C 2 * "Ack"/"Nak"

7-2-4-2 <STX> & <ETX> Characters

Scan below barcodes to set if need to add STX data(before the output barcode data) & ETX data(after the output barcode data).

 * A E 1 A 0 * None
 * A E 1 A 1 * Stx/Etx



7-2-4-3 <CMD> & <BAR> Characters

Scan the appropriate barcode to enable or disable <BAR> and <CMD> escape characters

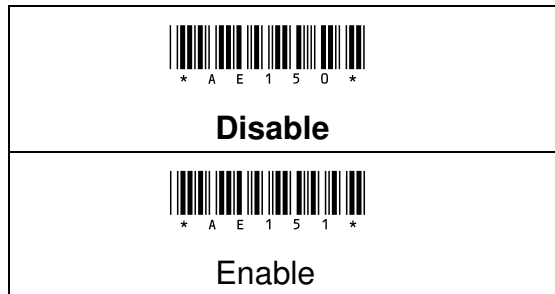

7-2-4-4 Command Mode

Scan the appropriate barcode to enable or disable Command mode for SPP.

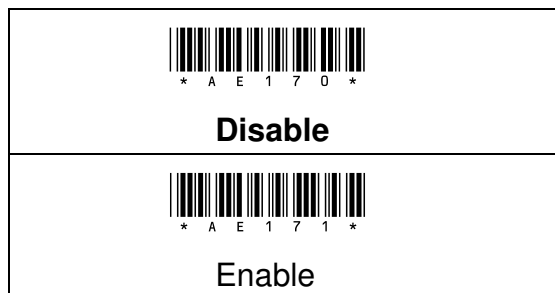

7-2-4-5 Retransmission Count

To avoid data transmission loss, messages sometimes have to be resent due to a failure to receive ACK signal.



Procedure:	Example:
(A) Scan "Enter" barcode (B) Scan "Retransmission Count" barcode (C) Scan parameters from Hexadecimal / Decimal table (D) Scan "OK" barcode (E) Scan "End" barcode	If configuration is 2 sec, the parameter value is 2 sec / 1 sec = 2

7-2-3-6 ACK Timeout

When the data set sent, how long shall receive ACK



Configuration Range	Unit	Default Setting
2 ~ 255 sec	1 sec	3

Procedure:	Example:
(A) Scan "Enter" barcode (B) Scan "ACK Timeout" barcode (C) Scan parameters from Hexadecimal / Decimal table (D) Scan "OK" barcode (E) Scan "End" barcode	If configuration is 2 sec, the parameter value is 2 sec / 1 sec = 2



7-2-4-7 Transmission specific symbols Delay time

Delay time after transmitting specific symbols



Configuration Range	Unit	Default Setting
0 ~ 2.5 sec	0.01 sec	0

Procedure:	Example:
(A) Scan "Enter" barcode (B) Scan "Transmission specific symbols Delay" barcode (C) Scan parameters from Hexadecimal / Decimal table (D) Scan "OK" barcode (E) Scan "End" barcode	If configuration is 0.02 sec, the parameter value is 0.02 sec / 0.01 sec = 2

7-2-4-8 Transmission Timeout

After sending the information, how long time did not respond will start timeout



Configuration Range	Unit	Default Setting
2 ~ 255 sec	1 sec	3

Procedure:	Example:
(A) Scan "Enter" barcode (B) Scan "Transmission Timeout" barcode (C) Scan parameters from Hexadecimal / Decimal table (D) Scan "OK" barcode (E) Scan "End" barcode	If configuration is 2 sec, the parameter value is 2 sec / 1 sec = 2



7-2-4-9 Transmission Char Delay

After setting the number of characters sent into the Delay time



Procedure

- (A) Scan “Enter” barcode
- (B) Scan “Transmission Char Delay” barcode
- (C) Scan parameters from Hexadecimal / Decimal table
- (D) Scan “OK” barcode
- (E) Scan “End” barcode

7-2-4-10 Transmission Char Gap Time

Time after sending characters to be sent the next character



Configuration Range	Unit	Default Setting
0.002 ~ 0.25 sec	0.001sec	2

Procedure:	Example:
<ul style="list-style-type: none"> (A) Scan “Enter” barcode (B) Scan “Transmission Char Gap Time” barcode (C) Scan parameters from Hexadecimal / Decimal table (D) Scan “OK” barcode (E) Scan “End” barcode 	<p>If configuration is 0.002 sec, the parameter value is 0.002 sec / 0.001 sec = 2</p>

Enter



185

End



7-2-4-11 Transmission Record Gap Time

This function can set Delay Time between 2 records.



Configuration Range	Unit	Default Setting
0~2.5 sec	0.01sec	0







Procedure:	Example:
(A) Scan "Enter" barcode (B) Scan "Transmission Record Gap Time" barcode (C) Scan parameters from Hexadecimal / Decimal table (D) Scan "OK" barcode (E) Scan "End" barcode	If configuration is 0.2 sec, the parameter value is 0.2 sec / 0.01 sec = 20



7-3 System Control



7-3-1 Mode

Set the controlling mode

 * A 4 0 C 0 * Cable
 * A 4 0 C 1 * Memory
 * A 4 0 C 2 * Cable & Memory
 * A 4 0 C 3 * Bluetooth
 * A 4 0 C 4 * Cable & Bluetooth
 * A 4 0 C 5 * Memory & Bluetooth
 * A 4 0 C 6 * Cable & Memory & Bluetooth

7-3-2 System Beep Sw

Whether it needs to activate Beep sound of system category (like power on music).

 * A 4 5 4 1 * Enable
 * A 4 5 4 0 * Disable

Enter









End





7-3-3 Date Format

Setting the date display format

 * A 4 2 C 0 * YYYYMMDD
 * A 4 2 C 1 * MMDDYYYY
 * A 4 2 C 2 * DDMMYYYY
 * A 4 2 C 3 * YYMMDD
 * A 4 2 C 4 * MMDDYY
 * A 4 2 C 5 * DDMMYY

7-3-4 Time Format

Setting the Time display format

 * A 4 2 A 0 * HHMMSS
 * A 4 2 A 1 * HHMM
 * A 4 2 A 2 * MMSS

Enter



End



7-3-5 Battery Charge Speed

When the machine is charging, fast or slow charge

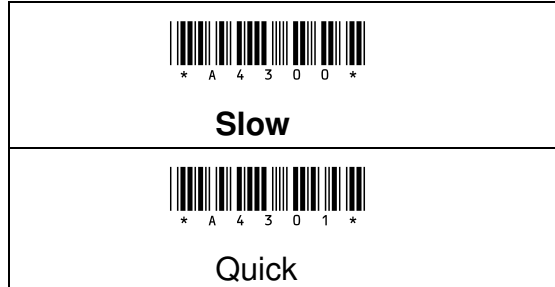



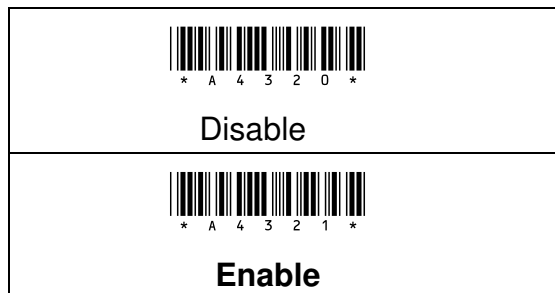

7-3-6 USB Plug to Cable Mode

Whether the machine connects with cable, it is forced back to Std mode, and it is no way to switch to other mode. When the machine does not connect with cable, it will go back to previous operating mode. If the previous operating mode is Std, it can choose next available operating mode. If it has no other operating mode, then it is Std





7-3-7 System Beep Volume

System Beep volume configuration enables to configure the volume of the Beep sound

 * A 4 5 8 0 *
Level1
 * A 4 5 8 1 *
Level2
 * A 4 5 8 2 *
Level3
 * A 4 5 8 3 *
Level4

7-3-8 System Vibrator



Whether it needs to activate warning vibration of system category

 * A 4 5 5 0 *
Disable
 * A 4 5 5 1 *
Enable





7-3-9 Setup Vibrator

When it enters into setting mode, whether it needs to vibrate

 * A 4 5 7 0 * Disable
 * A 4 5 7 1 * Enable



7-3-10 Header Str Sw

When it is during MemTx, whether send out the data of Header.

 * A 4 6 0 0 * Disable
 * A 4 6 0 1 * Enable

7-3-11 Header Serial Number

Whether when it shows Header data, also shows SerNum

 * A 4 6 1 0 * Disable
 * A 4 6 1 1 * Enable

Enter





End





7-3-12 Header Date & Time

Whether when it shows Header data, also shows date and time

 * A 4 6 2 0 *
Disable
 * A 4 6 2 1 *
Enable



7-3-13 Header Record Count

When output the data from the memory, whether need to display the total number of records on the Header area

 * A 4 6 3 0 *
Disable
 * A 4 6 3 1 *
Enable

7-3-14 Footer Str Sw

When MemTx, whether send out Footer data

 * A 4 7 0 0 *
Disable
 * A 4 7 0 1 *
Enable

Enter





192

End





7-3-15 Footer Serial Number

Whether when it shows Footer data, also show SerNum

 * A 4 7 1 0 *
Disable
 * A 4 7 1 1 *
Enable

7-3-16 Footer Date & Time



Whether when it shows Footer data, also shows date and time.

 * A 4 7 2 0 *
Disable
 * A 4 7 2 1 *
Enable



7-3-17 Footer Record Count

When output the data from the memory, whether need to display the total number of records on the Footer area

 * A 4 7 3 0 * Disable
 * A 4 7 3 1 * Enable

7-3-18 Lamp Light Brightness

Set the brightness of scanning light



Configuration Range	Default Setting
1-10	10

Procedure:

- (A) Scan "Enter" barcode
- (B) Scan "Lamp Light Brightness" barcode
- (C) Scan parameters from Hexadecimal / Decimal table
- (D) Scan "OK" barcode
- (E) Scan "End" barcode

Enter



End



7-3-19 DLE Escape Characters

Set Escape digits



Procedure:

- (A) Scan "Enter" barcode
- (B) Scan "DLE Escape Char" barcode
- (C) Scan parameters from Hexadecimal / Decimal table
- (D) Scan "OK" barcode
- (E) Scan "End" barcode

7-3-20 CMD Escape Characters

Set Cmd digits in Record Packed Format



Procedure:

- (A) Scan "Enter" barcode
- (B) Scan "CMD Escape Char" barcode
- (C) Scan parameters from Hexadecimal / Decimal table
- (D) Scan "OK" barcode
- (E) Scan "End" barcode

Enter



195

End



7-3-21 BAR Escape Characters

Set Bar digits in Record Packed Format// 02 OO data 03



Procedure:

- (A) Scan "Enter" barcode
- (B) Scan "BAR Escape Char" barcode
- (C) Scan parameters from Hexadecimal / Decimal table
- (D) Scan "OK" barcode
- (E) Scan "End" barcode

7-3-22 ETX Escape Characters

Set Etx digits



Procedure:

- (A) Scan "Enter" barcode
- (B) Scan "ETX Escape Char" barcode
- (C) Scan parameters from Hexadecimal / Decimal table
- (D) Scan "OK" barcode
- (E) Scan "End" barcode

Enter



196

End



7-3-23 STX Escape Characters

Set Stx digits



Procedure:

- (A) Scan "Enter" barcode
- (B) Scan "STX Escape Char" barcode
- (C) Scan parameters from Hexadecimal / Decimal table
- (D) Scan "OK" barcode
- (E) Scan "End" barcode

7-3-24 Date Separator

Set separation sign of date



Procedure:

- (A) Scan "Enter" barcode
- (B) Scan "Date Separator" barcode
- (C) Scan parameters from Hexadecimal / Decimal table
- (D) Scan "OK" barcode
- (E) Scan "End" barcode

Enter



197

End



7-3-25 Time Separator

Set separation sign of time



Procedure:

- (A) Scan "Enter" barcode
- (B) Scan "Time Separator" barcode
- (C) Scan parameters from Hexadecimal / Decimal table
- (D) Scan "OK" barcode
- (E) Scan "End" barcode

7-3-26 Wait Addon Count

Wait for the time of decoding add-on code. It needs to operate in coordination with UPCA, UPCE, EAN-13, EAN-8 barcode in "Wait Addon". If it gets Addon code in assigned decoding times, it will show Addon code, or not show addon code.



Procedure:

- (A) Scan "Enter" barcode
- (B) Scan "WaitAddon Count" barcode
- (C) Scan parameters from Hexadecimal / Decimal table
- (D) Scan "OK" barcode
- (E) Scan "End" barcode

Enter



198

End



7-3-27 Double Confirm Count

The Count of repeatedly confirmations



Configuration Range	Default Setting
1-10	1

Procedure:

- (A) Scan "Enter" barcode
- (B) Scan "Confirm Count" barcode
- (C) Scan parameters from Hexadecimal / Decimal table
- (D) Scan "OK" barcode
- (E) Scan "End" barcode

7-3-28 Continue Mode Clear Time

When the clearance time of scanner connects with USB Cable, after long time can be set to scan the same code can only be used under the "Continue" mode.



Configuration Range	Unit	Default Setting
0~2.5 Sec	0.01Sec	0.5Sec

Procedure:

- (A) Scan "Enter" barcode
- (B) Scan Transmission Timeout barcode
- (C) Scan parameters from Hexadecimal / Decimal table
- (D) Scan "OK" barcode
- (E) Scan "End" barcode

Example:

If configuration is 0.2 sec, the parameter value is **0.2 sec / 0.01 sec = 20**

Enter



199

End



7-3-29 Setup Time

Set when after enter into setting mode, it is Timeout if there is no action within a period of time.



Configuration Range	Unit	Default Setting
0~255 Sec	1 Sec	60 Sec

Procedure:	Example:
(A) Scan "Enter" barcode (B) Scan Transmission Timeout barcode (C) Scan parameters from Hexadecimal / Decimal table (D) Scan "OK" barcode (E) Scan "End" barcode	If configuration is 2 sec, the parameter value is 2 sec / 1 sec = 2

7-3-30 Set Date & Time Format

It is able to read below barcodes to set the Year/Month/Date/Time (YYMMDDhhmmss)



Procedure:
(A) Scan "Enter" Barcode (B) Scan "Set Date & Time Format" Barcode (C) Scan parameters from Hexadecimal / Decimal table (D) Scan "OK" barcode (E) Scan "End" Barcode

Enter



200

End



7-3-31 All Memory Data Clear

When scan this barcode, all the barcode data in memory will be cleared



7-3-32 All Data Transmission

When scan this barcode, it is able to output the data in the memory.



7-3-33 Footer Characters

When output the barcode data from memory, the Footer is able to change to what the string you need, max is 12 characters.



Procedure:

- (A) Scan "Enter" barcode
- (B) Scan "Footer Characters" barcode
- (C) Scan parameters from Hexadecimal / Decimal table
- (D) Scan "OK" barcode
- (E) Scan "End" barcode

Enter



201

End



7-3-34 Header Characters

When output the barcode data from memory, the Header is able to change to what the string you need, max is 12 characters.



Procedure:

- (A) Scan "Enter" barcode
- (B) Scan "Header" Characters" barcode
- (C) Scan parameters from Hexadecimal / Decimal table
- (D) Scan "OK" barcode
- (E) Scan "End" barcode

Enter



202

End



Chapter 8: Symbology Settings

Symbology Settings

8-1 Barcode Symbologies Default setting chart

8-2 UPC-A

8-3 UPC-E

8-4 EAN-13

8-5 EAN-8

8-6 Code-39

8-7 Codebar/NW7

8-8 Code-128

8-9 Interleaved 2 of 5

8-10 Industrial 2 of 5

8-11 Matrix 2 of 5

8-12 Code-93

8-13 Code-11

8-14 MSI/Plessey

8-15 UK/Plessey

8-16 Telepen

8-17 RSS(GS1 DataBar)14

8-18 RSS(GS1 DataBar) Limited

8-19 RSS(GS1 DataBar)14 Stack

8-20 RSS(GS1 DataBar) Expansion

8-21 RSS(GS1 DataBar) Expansion Stack

Enter



203

End



8. Symbology Settings

8 - 1 Barcode Symbologies Default setting

Barcode type	Read	Length		Truncate		Code ID/	Sub Code ID
		Min.	Max	Lead	End		
UPC-A	Enable	—	—	1	0	A	—
UPC-E	Enable	—	—	0	0	E	E
EAN-13	Enable	—	—	0	0	F	F
EAN-8	Enable	—	—	0	0	FF	FF
Code-39	Enable	0	0	0	0	M	M
Codebar/NW7	Enable	0	0	0	0	N	—
Code-128	Enable	0	0	0	0	K	K
Interleaved 2 of 5	Disable	0	0	0	0	I	—
Industrial 2 of 5	Disable	0	0	0	0	J	—
Matrix 2 of 5	Disable	0	0	0	0	G	—
Code-93	Disable	0	0	0	0	L	—
Code-11	Disable	0	0	0	0	O	—
MSI/Plessey	Disable	0	0	0	0	P	—
UK/Plessey	Disable	0	0	0	0	R	—
Telepen	Disable	0	0	0	0	S	—
RSS(GS1 DataBar)14	Disable	—	—	0	0	T	—
RSS(GS1 DataBar) Limited	Disable	—	—	0	0	U	—
RSS(GS1 DataBar)14 Stack	Disable	—	—	0	0	V	—
RSS(GS1 DataBar) Expansion	Disable	—	—	0	0	W	—
RSS(GS1 DataBar) Expansion Stack	Disable	—	—	0	0	X	—

Enter



204

End



8 - 2 UPC-A

8- 2-1 Read

UPC-A barcode symbology configuration

 * 0 0 0 0 0 *
Disable
 * 0 0 0 0 1 *
Enable

8- 2-2 Add – on Type

The add-on barcode is the supplemental 2 or 5 characters for WPC code. User can configure, Add-on2, Add-on5 or Add-on2+5 supplemental characters.

 * 0 1 9 0 *
None
 * 0 1 9 1 *
Add-on 2
 * 0 1 9 2 *
Add-on 5
 * 0 1 9 3 *
Add-on 2+5

Enter



205

End



8-2-3 Wait Add – on

It is recommended to set Enable if you want the UPC can be output with add-on code together. Please enable this function first and refer Wait Add-on count for the reading of Add-on code.

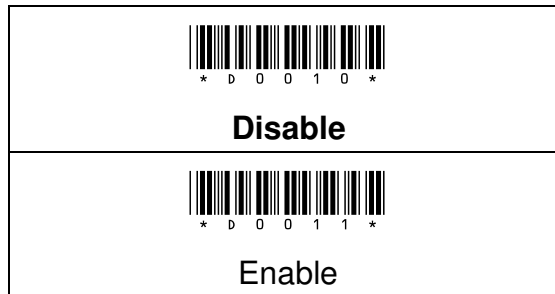

8-2-4 Truncate Leading Zeros

When the barcode leading have "0", you can configured this function to truncate all leading "0" of barcode.

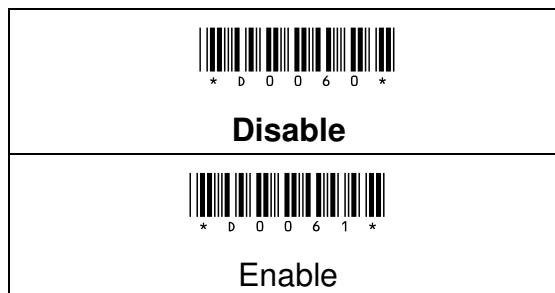

Enter



206

End



8-2-5 Transmission Checksum

The option enables to display the check digits.

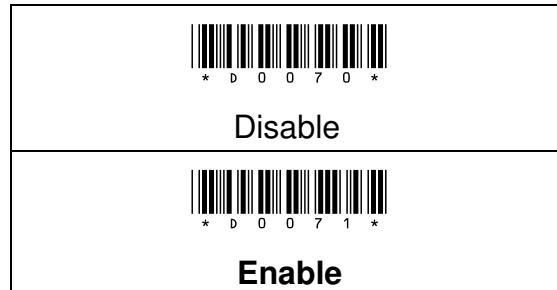

8-2-6 Truncate Leading Characters

This enables to truncate the barcode data from the beginning of the barcode



Procedure:

- (A) Scan "Enter" barcode
- (B) Scan "Truncate Leading Characters" barcode
- (C) Scan parameters from Hexadecimal / Decimal table
- (D) Scan "OK" barcode
- (E) Scan "End" barcode

Enter



207

End



8-2-7 Truncate Trailing Characters

This enables to truncate the barcode data from the Ending of the barcode



Procedure:

- (A) Scan "Enter" barcode
- (B) Scan "Truncate Trailing Characters" barcode
- (C) Scan parameters from Hexadecimal / Decimal table
- (D) Scan "OK" barcode
- (E) Scan "End" barcode

8-2-8 Position for Inserting

The position of the data insertion, if the insertion data position is in the first position of the barcode data, specify as 0. If the insertion data position is behind the barcode data, specify as 255. (Range:0-255)

Ins0Pos



Ins1Pos



Procedure:

- (A) Scan "Enter" barcode
- (B) Scan "Ins0Pos" or "Ins1Pos" barcode
- (C) Scan parameters from Hexadecimal / Decimal table
- (D) Scan "OK" barcode
- (E) Scan "End" barcode

Enter



208

End



8-2-9 Position for Inserting Characters

User can specify the characters in the Insert Position

Ins0PosChar



Ins1PosChar



Procedure:

- (A) Scan "Enter" barcode
- (B) Scan "Ins0Poschar" or "Ins1Poschar" barcode
- (C) Scan parameters from Hexadecimal / Decimal table
- (D) Scan "OK" barcode
- (E) Scan "End" barcode

8-2-10 Code ID for UPC-A

ID data set barcode



Procedure:

- (A) Scan "Enter" barcode
- (B) Scan "Code ID for UPC-A" barcode
- (C) Scan parameters from Hexadecimal / Decimal table
- (D) Scan "OK" barcode
- (E) Scan "End" barcode

Enter



209

End



8-3 UPC-E

8-3-1 Read

UPC-E barcode symbology configuration

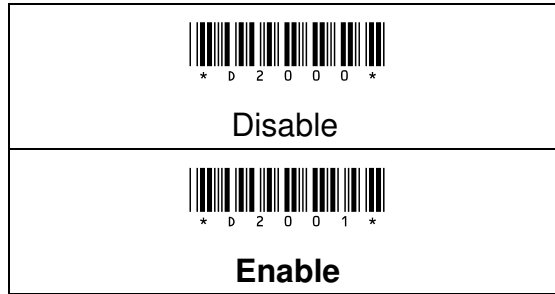

8-3-2 Wait Add-On

It is recommended to set Enable if you want the UPC can be output with add-on code together. Please enable this function first and refer Wait Add-on count for the reading of Add-on code.

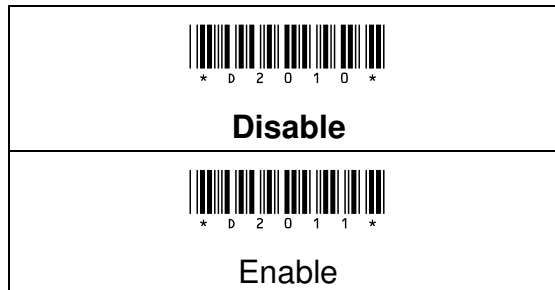

Enter



210

End



8-3-3 Expansion

This expansion function is for UPC-E and EAN-8 only. It will extend the barcode to be 13-digits by "0".

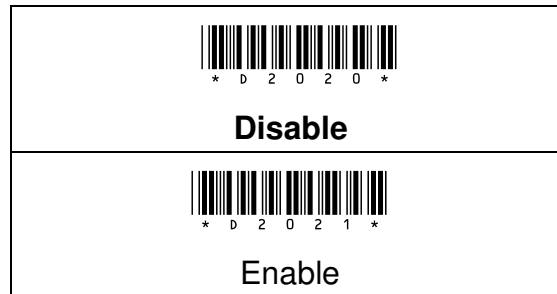

8-3-4 Add-On Type

The add-on barcode is the supplemental 2 or 5 characters for WPC code. User can configure, Add-on2, Add-on5 or Add-on2+5 supplemental characters.

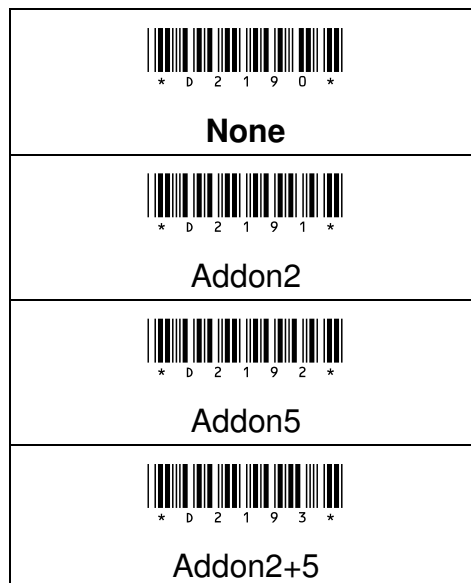

8-3-5 Transmission Checksum

The option enables to display the check digits.

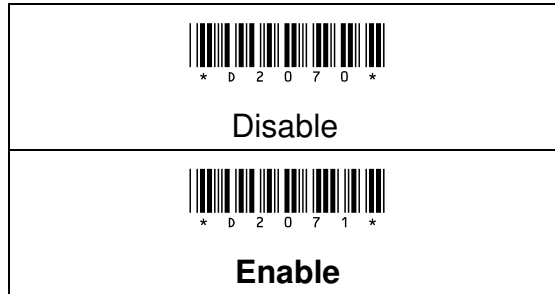

8-3-6 Truncate Leading Zeros

When the barcode leading have "0", you can configured this function to truncate all leading "0" of barcode.

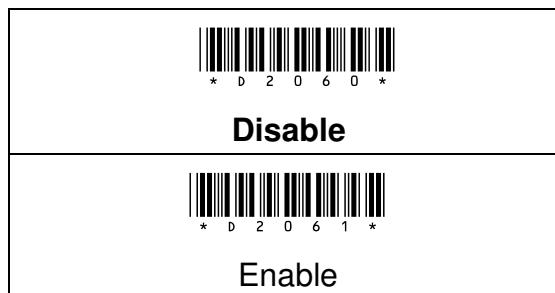

8-3-7 Truncate Leading Characters

This enables to truncate the barcode data from the beginning of the barcode



Procedure:

- (A) Scan "Enter" barcode
- (B) Scan "Truncate Leading Characters" barcode
- (C) Scan parameters from Hexadecimal / Decimal table
- (D) Scan "OK" barcode
- (E) Scan "End" barcode

8-3-8 Truncate Trailing Characters

This enables to truncate the barcode data from the Ending of the barcode



Procedure:

- (A) Scan "Enter" barcode
- (B) Scan "Truncate Trailing Characters" barcode
- (C) Scan parameters from Hexadecimal / Decimal table
- (D) Scan "OK" barcode
- (E) Scan "End" barcode

Enter



213

End



8-3-9 Position for Inserting

The position of the data insertion, if the insertion data position is in the first position of the barcode data, specify as 0. If the insertion data position is behind the barcode data, specify as 255. (Range:0-255)

Ins0Pos



Ins1Pos



Procedure:

- (A) Scan "Enter" barcode
- (B) Scan "Ins0Pos" or "Ins1Pos" barcode
- (C) Scan parameters from Hexadecimal / Decimal table
- (D) Scan "OK" barcode
- (E) Scan "End" barcode

8-3-10 Position for Inserting characters

User can specify the characters in the Insert Position

Ins0PosChar



Ins1PosChar



Procedure:

- (A) Scan "Enter" barcode
- (B) Scan "Ins0Poschar" or "Ins1Poschar" barcode
- (C) Scan parameters from Hexadecimal / Decimal table
- (D) Scan "OK" barcode
- (E) Scan "End" barcode

Enter



214

End



8-3-11 Code ID for UPC-E

Code ID set barcode



Procedure:

- (A) Scan "Enter" barcode
- (B) Scan "Code ID for UPC-E" barcode
- (C) Scan parameters from Hexadecimal / Decimal table
- (D) Scan "OK" barcode
- (E) Scan "End" barcode

8-3-12 Sub Code ID for UPC-E

Sub Code ID set barcode



Procedure:

- (A) Scan "Enter" barcode
- (B) Scan "Sub Code ID for UPC-E" barcode
- (C) Scan parameters from Hexadecimal / Decimal table
- (D) Scan "OK" barcode
- (E) Scan "End" barcode

Enter



215

End



8-4 EAN-13

8-4-1 Read

EAN-13 barcode symbology configuration

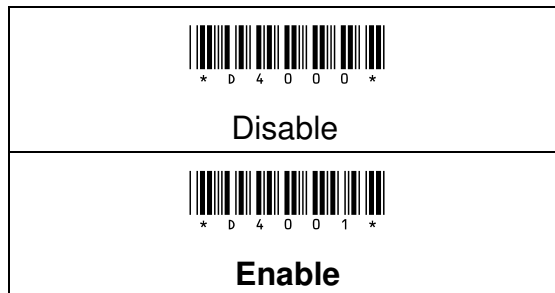

8-4-2 Wait Add-On

It is recommended to set Enable if you want the UPC can be output with add-on code together. Please enable this function first and refer Wait Add-on count for the reading of Add-on code.

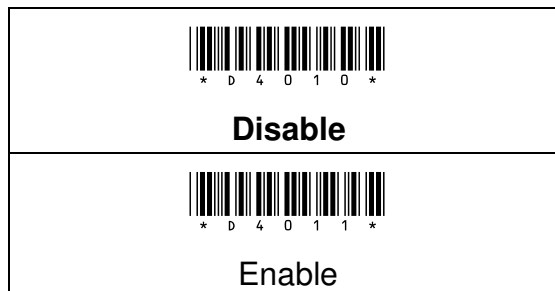

Enter



216

End





8- 4- 3 Add-On Type

The add-on barcode is the supplemental 2 or 5 characters for WPC code. User can configure, Add-on2, Add-on5 or Add-on2+5 supplemental characters.

 None	 Addon2
 Addo©©©n 5	 Addon2+5

8-4-4 ISBN / ISSN Conversion

The ISBN (International Standard Book Number) and ISSN (International Standard Serial Number) are especial barcode for books and magazines. The ISBN has 10 digits with leading "978" and the ISSN has 8 digits with leading "977" of EAN-13 symbology.

 Disable
 Enable

Example:

Example Barcode data "9789572222720"

Output: "9572222724"

Example Barcode data "9771019248004"

Output: "10192484"



8-4-5 Truncate Leading Zeros

When the barcode leading have "0", you can configured this function to truncate all leading "0" of barcode.

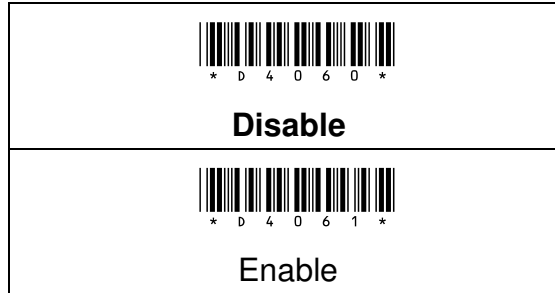

8-4-6 Transmission Checksum

The option enables to display the check digits.

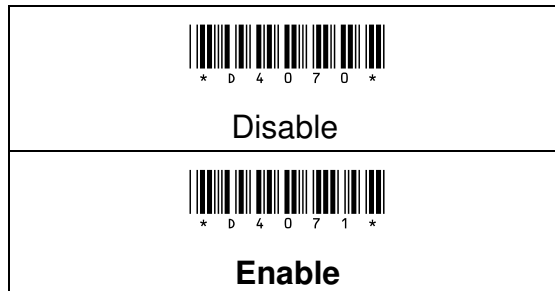

8-4-7 Truncate Leading Characters

This enables to truncate the barcode data from the beginning of the barcode



Procedure:

- (A) Scan "Enter" barcode
- (B) Scan "Truncate Leading Characters" barcode
- (C) Scan parameters from Hexadecimal / Decimal table
- (D) Scan "OK" barcode
- (E) Scan "End" barcode

8-4-8 Truncate Trailing Characters

This enables to truncate the barcode data from the Ending of the barcode



Procedure:

- (A) Scan "Enter" barcode
- (B) Scan "Truncate Trailing Characters" barcode
- (C) Scan parameters from Hexadecimal / Decimal table
- (D) Scan "OK" barcode
- (E) Scan "End" barcode

Enter



219

End



8-4-9 Position for Inserting

The position of the data insertion, if the insertion data position is in the first position of the barcode data, specify as 0. If the insertion data position is behind the barcode data, specify as 255. (Range:0-255)

Ins0Pos



Ins1Pos



Procedure:

- (A) Scan "Enter" barcode
- (B) Scan "Ins0Pos" or "Ins1Pos" barcode
- (C) Scan parameters from Hexadecimal / Decimal table
- (D) Scan "OK" barcode
- (E) Scan "End" barcode

8-4-10 Position for Inserting characters

User can specify the characters in the Insert Position

Ins0PosChar



Ins1PosChar



Procedure:

- (A) Scan "Enter" barcode
- (B) Scan "Ins0Poschar" or "Ins1Poschar" barcode
- (C) Scan parameters from Hexadecimal / Decimal table
- (D) Scan "OK" barcode
- (E) Scan "End" barcode

Enter



220

End



8-4-11 Code ID for EAN-13

Code ID set barcode



Procedure:

- (A) Scan "Enter" barcode
- (B) Scan "Code ID for EAN-13" barcode
- (C) Scan parameters from Hexadecimal / Decimal table
- (D) Scan "OK" barcode
- (E) Scan "End" barcode

8-4-12 Sub Code ID for EAN-13

Sub Code ID set barcode



Procedure:

- (A) Scan "Enter" barcode
- (B) Scan "Sub Code ID for EAN-13" barcode
- (C) Scan parameters from Hexadecimal / Decimal table
- (D) Scan "OK" barcode
- (E) Scan "End" barcode

Enter



221

End



8-5 EAN-8

8-5-1 Read

EAN-8 barcode symbology configuration.

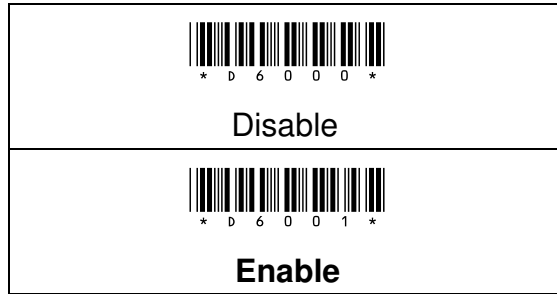

8-5-2 Wait Add-On

It is recommended to set Enable if you want the UPC can be output with add-on code together. Please enable this function first and refer Wait Add-on count for the reading of Add-on code

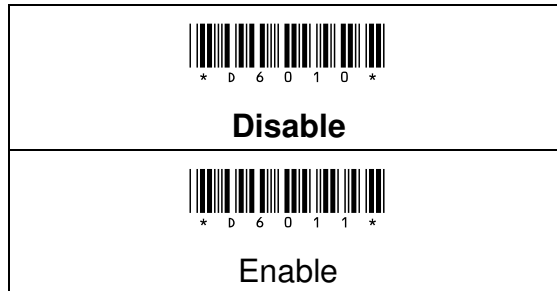

8-5-3 Add-On Type

The add-on barcode is the supplemental 2 or 5 characters for WPC code. User can configure, Add-on2, Add-on5 or Add-on2+5 supplemental characters.

<p>None</p>	<p>Addon2</p>
<p>Addon5</p>	<p>Addon2+5</p>

8-5-4 Expansion

This expansion function is for UPC-E and EAN-8 only. It will extend the barcode to be 13-digits by "0".

Example Barcode "01236547" Output "001236000057"

<p>Disable</p>
<p>Enable</p>



8-5-5 Transmission Checksum

The option enables to display the check digits.

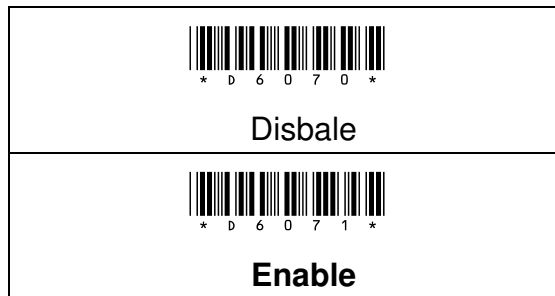

8-5-6 Truncate Leading Zeros

When the barcode leading have "0", you can configured this function to truncate all leading "0" of barcode.

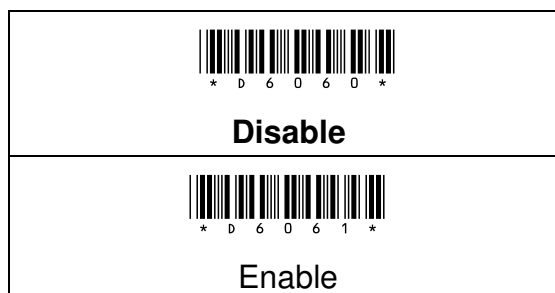

8-5-7 Truncate Leading Characters

This enables to truncate the barcode data from the beginning of the barcode



Procedure:

- (A) Scan "Enter" barcode
- (B) Scan "Truncate Leading Characters" barcode
- (C) Scan parameters from Hexadecimal / Decimal table
- (D) Scan "OK" barcode
- (E) Scan "End" barcode

8-5-8 Truncate Trailing Characters

This enables to truncate the barcode data from the Ending of the barcode



Procedure:

- (A) Scan "Enter" barcode
- (B) Scan "Truncate Trailing Characters" barcode
- (C) Scan parameters from Hexadecimal / Decimal table
- (D) Scan "OK" barcode
- (E) Scan "End" barcode

Enter



225

End



8-5-9 Position for Inserting

The position of the data insertion, if the insertion data position is in the first position of the barcode data, specify as 0. If the insertion data position is behind the barcode data, specify as 255. (Range:0-255)

Ins0Pos



Ins1Pos



Procedure:

- (A) Scan "Enter" barcode
- (B) Scan "Ins0Pos" or "Ins1Pos" barcode
- (C) Scan parameters from Hexadecimal / Decimal table
- (D) Scan "OK" barcode
- (E) Scan "End" barcode

8-5-10 Position for Inserting characters

User can specify the characters in the Insert Position

Ins0PosChar



Ins1PosChar



Procedure:

- (A) Scan "Enter" barcode
- (B) Scan "Ins0Poschar" or "Ins1Poschar" barcode
- (C) Scan parameters from Hexadecimal / Decimal table
- (D) Scan "OK" barcode
- (E) Scan "End" barcode

Enter



226

End



8-5-11 Code ID for EAN-8

Code ID set barcode



Procedure:

- (A) Scan "Enter" barcode
- (B) Scan "Code ID for UPC-A" barcode
- (C) Scan parameters from Hexadecimal / Decimal table
- (D) Scan "OK" barcode
- (E) Scan "End" barcode

8-5-12 Sub Code ID for EAN-8

Sub Code ID set barcode



Procedure:

- (A) Scan "Enter" barcode
- (B) Scan "Sub Code ID for EAN-8" barcode
- (C) Scan parameters from Hexadecimal / Decimal table
- (D) Scan "OK" barcode
- (E) Scan "End" barcode

Enter



227

End



8-6 Code-39

8-6-1 Read

Code-39 barcode symbology configuration.

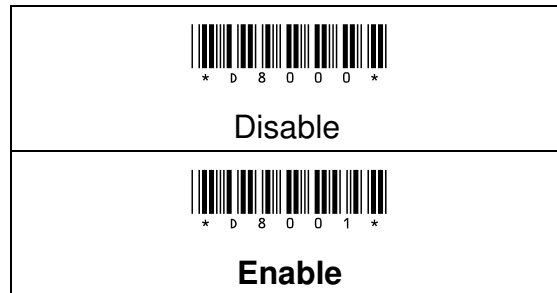

8-6-2 Type

The Full ASCII function is an enhanced setting for Code-39 which is with total 128 digits to represent Full ASCII code. It must be combined by either one of +, %, \$ or / and one of alpha character (A to Z).

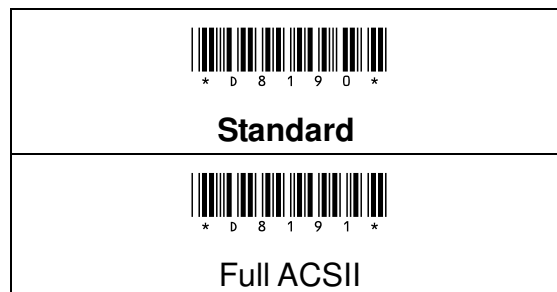

Enter



228

End



8-6-3 Code 32 Translation

The Code-32 symbology (Italian Pharmaceutical) is another version of Code-39 which maximum can be 10 digits and can be 0 – 9 digits. The leading A is an optional character and can be set to be transmitted or not.

<p>* D 8 1 A 0 *</p> <p>None</p>
<p>* D 8 1 A 1 *</p> <p>Code-32</p>
<p>* D 8 1 A 2 *</p> <p>Code-32 with 'A'</p>

8-6-4 Transmission Start/ End

The Start and End character of Code-39 with "*". You can transmit all data digits including two "*" by set "Enable".

<p>* D 8 0 3 0 *</p> <p>Disable</p>
<p>* D 8 0 3 1 *</p> <p>Enable</p>

Enter



End



8-6-5 Checksum Verification

The option enables to verify the check digits, if this option is enable, any barcodes without check digits will not be able to scan.

The checksum of Code-39 is optional and it is made the sum module 43 as the numerical value of the data digits.

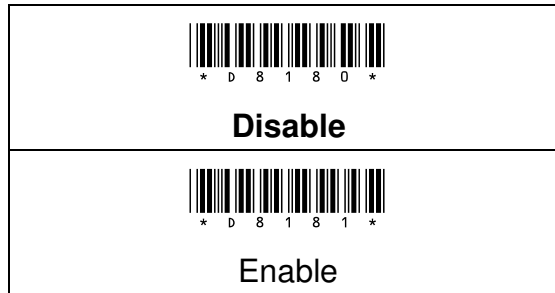

8-6-6 Transmission Checksum

The option enables to display the check digits.

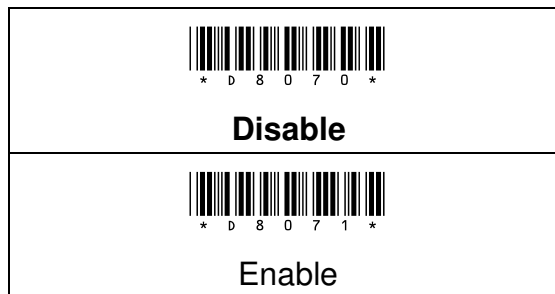

8-6-7 Truncate Leading Zeros

When the barcode leading have "0", you can configured this function to truncate all leading "0" of barcode.

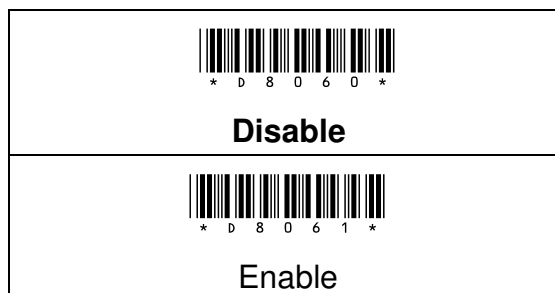

8-6-8 Min/Max Code Length

If barcode data length is less than the Min length or more than the Max length, it will not be able to read this code. Default "0" represents no limits on barcode length.

LenMin



LenMax



Procedure:

- (A) Scan "Enter" barcode
- (B) Scan "LenMin" or "LenMax" barcode
- (C) Scan parameters from Hexadecimal / Decimal table
- (D) Scan "OK" barcode
- (E) Scan "End" barcode

8-6-9 Truncate Leading Characters

This enables to truncate the barcode data from the beginning of the barcode



Procedure:

- (A) Scan "Enter" barcode
- (B) Scan "Truncate Leading Characters" barcode
- (C) Scan parameters from Hexadecimal / Decimal table
- (D) Scan "OK" barcode
- (E) Scan "End" barcode

Enter



231

End



8-6-10 Truncate Trailing Characters

This enables to truncate the barcode data from the Ending of the barcode

**Procedure:**

- (A) Scan "Enter" barcode
- (B) Scan "Truncate Trailing Characters" barcode
- (C) Scan parameters from Hexadecimal / Decimal table
- (D) Scan "OK" barcode
- (E) Scan "End" barcode

8-6-11 Position for Inserting

The position of the data insertion, if the insertion data position is in the first position of the barcode data, specify as 0. If the insertion data position is behind the barcode data, specify as 255. (Range:0-255)

Ins0Pos



Ins1Pos

**Procedure:**

- (A) Scan "Enter" barcode
- (B) Scan "Ins0Pos" or "Ins1Pos" barcode
- (C) Scan parameters from Hexadecimal / Decimal table
- (D) Scan "OK" barcode
- (E) Scan "End" barcode

Enter



232

End



8-6-12 Position for Inserting characters

User can specify the characters in the Insert Position

Ins0PosChar



Ins1PosChar



Procedure:

- (A) Scan "Enter" barcode
- (B) Scan "Ins0Poschar" or "Ins1Poschar" barcode
- (C) Scan parameters from Hexadecimal / Decimal table
- (D) Scan "OK" barcode
- (E) Scan "End" barcode

8-6-13 Code ID for Code-39

Code ID Set barcode



Procedure:

- (A) Scan "Enter" barcode
- (B) Scan "Code ID for Code-39" barcode
- (C) Scan parameters from Hexadecimal / Decimal table
- (D) Scan "OK" barcode
- (E) Scan "End" barcode

Enter



233

End



8-6-14 Sub Code ID for Code-39

Sub Code ID Set barcode



Procedure:

- (A) Scan "Enter" barcode
- (B) Scan "Sub Code ID for Code-39" barcode
- (C) Scan parameters from Hexadecimal / Decimal table
- (D) Scan "OK" barcode
- (E) Scan "End" barcode

Enter



234

End



8-7 Codabar / NW7

8-7-1 Read

Codabar /NW7 barcode symbology configuration.

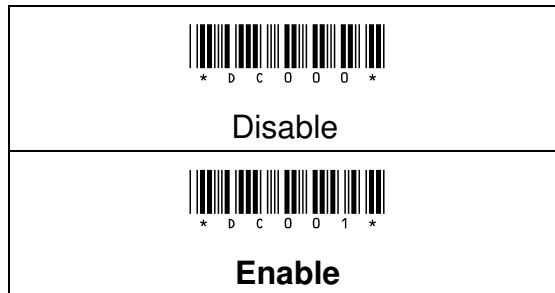

8-7-2 Start/ End Symbol types

The Codabar has four kinds of Start/End patterns; you may choose one to match your application.



Enter



235

End



8-7-3 Same Start/ End Pair

Sometimes, the Codabar requires only same Start/End pattern can be decoded.

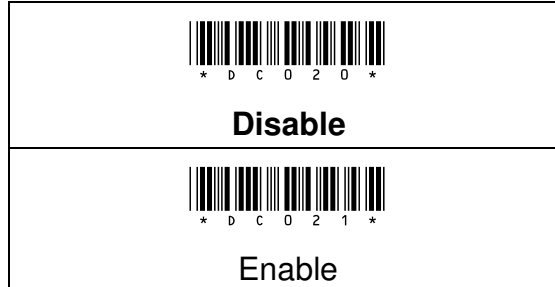

8-7-4 Transmission Start/ End

Configuration of transmit all data digits including Start/End

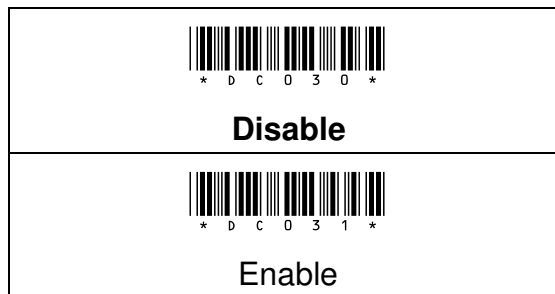

Enter



236

End



8-7-5 Checksum Verification

The option enables to verify the check digits, if this option is enable, any barcodes without check digits will not be able to scan

The checksum is made as the sum module 16 of the numerical values of all data digits.

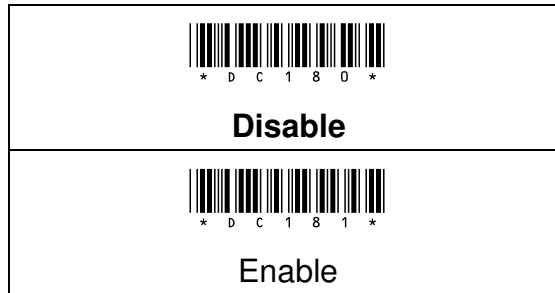

8-7-6 Transmission Checksum

The option enables to display the check digits.

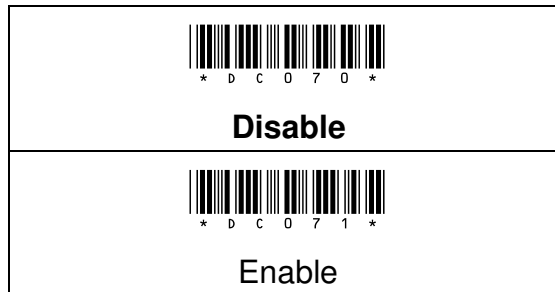

8-7-7 Truncate Leading Zero

When the barcode leading have “0”, you can configured this function to truncate all leading “0” of barcode

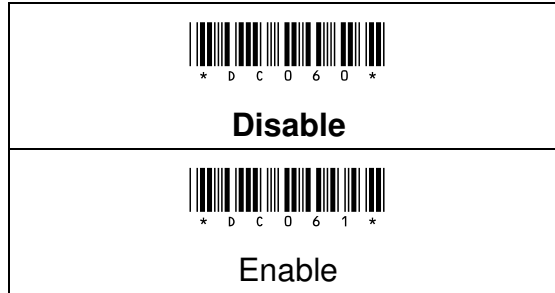

8-7-8 Min/Max Code Length

If barcode data length is less then the Min length or more then the Max length, it will not be able to read this code. Default “0” represents no limits on barcode length.

LenMin



LenMax

**Procedure:**

- (A) Scan “Enter” barcode
- (B) Scan “LenMin” or “LenMax” barcode
- (C) Scan parameters from Hexadecimal / Decimal table
- (D) Scan “OK” barcode
- (E) Scan “End” barcode

Enter



238

End



8-7-9 Truncate Leading Characters

This enables to truncate the barcode data from the beginning of the barcode



Procedure:

- (A) Scan "Enter" barcode
- (B) Scan "Truncate Leading Characters" barcode
- (C) Scan parameters from Hexadecimal / Decimal table
- (D) Scan "OK" barcode
- (E) Scan "End" barcode

8-7-10 Truncate Trailing Characters

This enables to truncate the barcode data from the Ending of the barcode



Procedure:

- (A) Scan "Enter" barcode
- (B) Scan "Truncate Trailing Characters" barcode
- (C) Scan parameters from Hexadecimal / Decimal table
- (D) Scan "OK" barcode
- (E) Scan "End" barcode

Enter



239

End



8-7-11 Position for Inserting

The position of the data insertion, if the insertion data position is in the first position of the barcode data, specify as 0. If the insertion data position is behind the barcode data, specify as 255. (Range:0-255)

Ins0Pos



Ins1Pos



Procedure:

- (A) Scan "Enter" barcode
- (B) Scan "Ins0Pos" or "Ins1Pos" barcode
- (C) Scan parameters from Hexadecimal / Decimal table
- (D) Scan "OK" barcode
- (E) Scan "End" barcode

8-7-12 Position for Inserting characters

User can specify the characters in the Insert Position

Ins0PosChar



Ins1PosChar



Procedure:

- (A) Scan "Enter" barcode
- (B) Scan "Ins0Poschar" or "Ins1Poschar" barcode
- (C) Scan parameters from Hexadecimal / Decimal table
- (D) Scan "OK" barcode
- (E) Scan "End" barcode

Enter



240

End



8-7-13 Code ID for Codabar/NW7

Code ID set barcode



Procedure:

- (A) Scan "Enter" barcode
- (B) Scan "Code ID for Codabar/NW7" barcode
- (C) Scan parameters from Hexadecimal / Decimal table
- (D) Scan "OK" barcode
- (E) Scan "End" barcode

Enter



241

End



8-8 Code 128

8-8-1 Read

Code- 128 barcode symbology configuration.

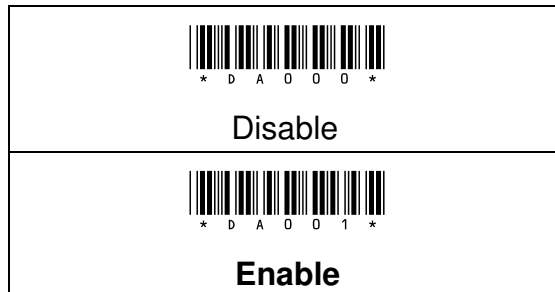

8-8-2 Type

The Code-128 can be translated to UCC-128 format if it starts with FNC1 character. The first FNC1 will be translated to "]C1", and next to be a connection code as <GS>

UCC-128 data format:

]C1	Data	<GS>	Data	Checksum
-----	------	------	------	----------

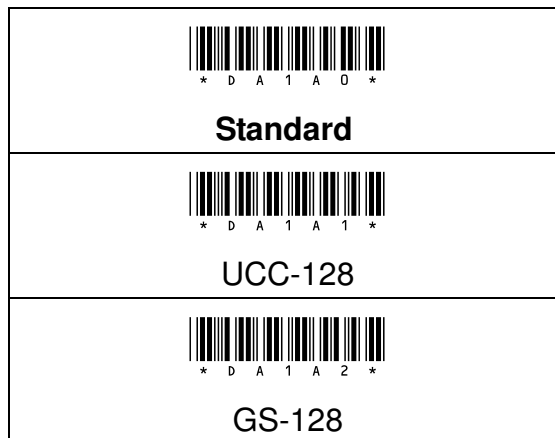

Enter



242

End



8-8-3 Checksum Verification

The option enables to verify the check digits, if this option is enable, any barcodes without check digits will not be able to scan.

The checksum is presented as the sum module 103 of all data digits.

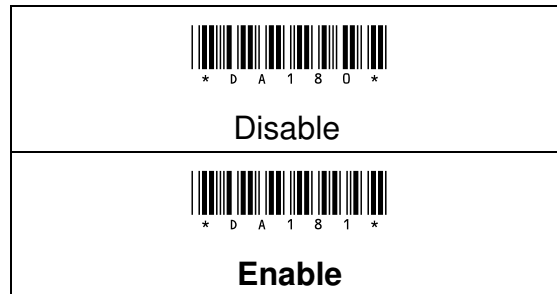

8-8-4 Transmission Checksum

The option enables to display the check digits.

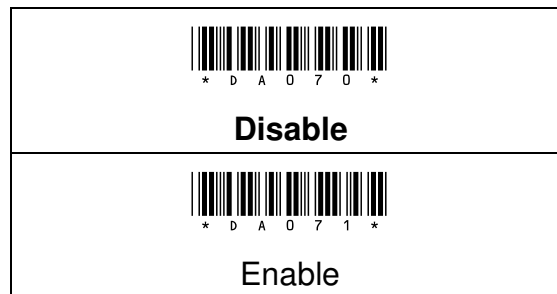

8-8-5 Truncate Leading Zeros

When the barcode leading have "0", you can configured this function to truncate all leading "0" of barcode

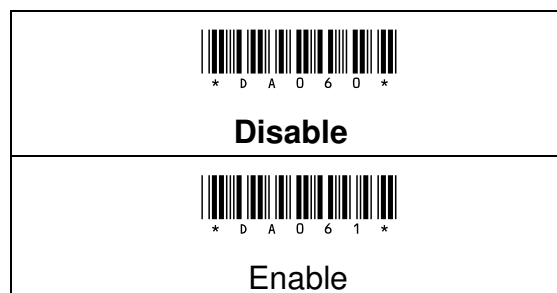

Enter



243

End



8-8-6 ID Separator for UCC-128/GS1-128

If “Type” is “GS-128”, you can set this function to set connect data



Procedure:

- (A) Scan “Enter” barcode
- (B) Scan “ID Separator for UCc-128/GS-128” barcode
- (C) Scan parameters from Hexadecimal / Decimal table
- (D) Scan “OK” barcode
- (E) Scan “End” barcode

8-8-7 Min/Max Code Length

If barcode data length is less then the Min length or more then the Max length, it will not be able to read this code. Default “0” represents no limits on barcode length.

LenMin



LenMax



Procedure:

- (A) Scan “Enter” barcode
- (B) Scan “LenMin” or “LenMax” barcode
- (C) Scan parameters from Hexadecimal / Decimal table
- (D) Scan “OK” barcode
- (E) Scan “End” barcode

Enter



244

End



8-8-8 Truncate Leading Characters

This enables to truncate the barcode data from the beginning of the barcode



Procedure:

- (A) Scan "Enter" barcode
- (B) Scan "Truncate Leading Characters" barcode
- (C) Scan parameters from Hexadecimal / Decimal table
- (D) Scan "OK" barcode
- (E) Scan "End" barcode

8-8-9 Truncate Trailing Characters

This enables to truncate the barcode data from the Ending of the barcode



Procedure:

- (A) Scan "Enter" barcode
- (B) Scan "Truncate Trailing Characters" barcode
- (C) Scan parameters from Hexadecimal / Decimal table
- (D) Scan "OK" barcode
- (E) Scan "End" barcode

Enter



245

End



8-8-10 Position for Inserting

The position of the data insertion, if the insertion data position is in the first position of the barcode data, specify as 0. If the insertion data position is behind the barcode data, specify as 255. (Range:0-255)

Ins0Pos



Ins1Pos

**Procedure:**

- (A) Scan "Enter" barcode
- (B) Scan "Ins0Pos" or "Ins1Pos" barcode
- (C) Scan parameters from Hexadecimal / Decimal table
- (D) Scan "OK" barcode
- (E) Scan "End" barcode

8-8-11 Position for Inserting characters

User can specify the characters in the Insert Position

Ins0PosChar



Ins1PosChar

**Procedure:**

- (A) Scan "Enter" barcode
- (B) Scan "Ins0Poschar" or "Ins1Poschar" barcode
- (C) Scan parameters from Hexadecimal / Decimal table
- (D) Scan "OK" barcode
- (E) Scan "End" barcode

Enter



246

End



8-8-12 Code ID for Code 128

Code ID set barcode



Procedure:

- (A) Scan "Enter" barcode
- (B) Scan "Code ID for Code 128" barcode
- (C) Scan parameters from Hexadecimal / Decimal table
- (D) Scan "OK" barcode
- (E) Scan "End" barcode

8-8-13 Sub Code ID for Code 128

Sub Code ID set barcode



Procedure:

- (A) Scan "Enter" barcode
- (B) Scan "Sub Code ID for Code 128" barcode
- (C) Scan parameters from Hexadecimal / Decimal table
- (D) Scan "OK" barcode
- (E) Scan "End" barcode

Enter



247

End



8-9 Interleaved 2 of 5

8-9-1 Read

Interleaved 2 of 5 barcode symbology configuration

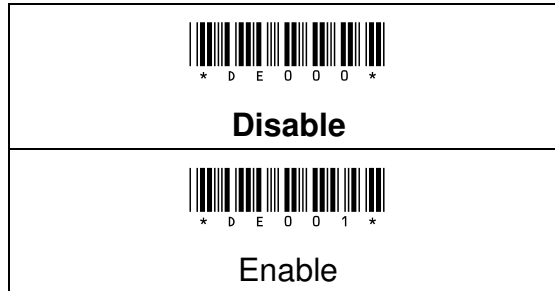

8-9-2 Checksum Verification

The option enables to verify the check digits, if this option is enable, any barcodes without check digits will not be able to scan
 The checksum is made the sum module 10 as the numerical values of all data digits.

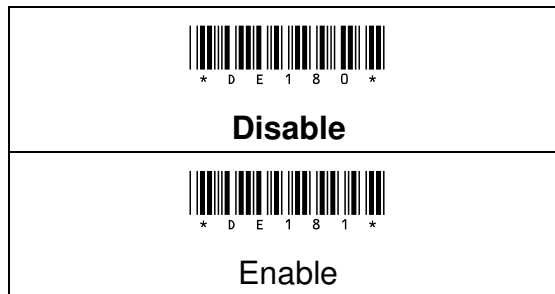

8-9-3 Transmission Checksum

The option enables to display the check digits.

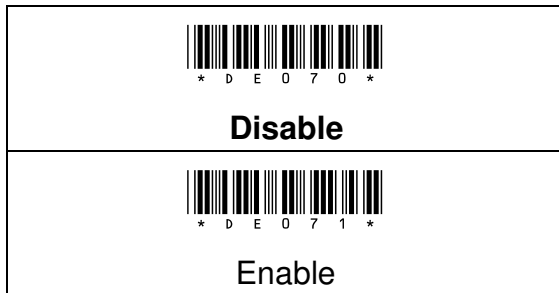

8-9-4 Truncate Leading Zeros

When the barcode leading have "0", you can configured this function to truncate all leading "0" of barcode

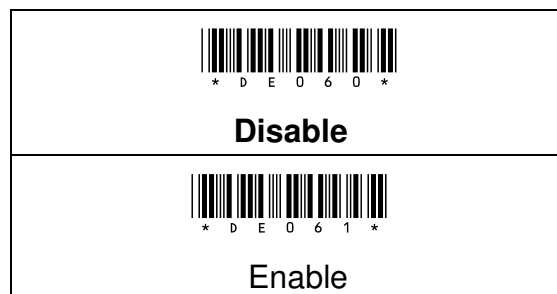

Enter



249

End



8-9-5 Min/Max Code Length

If barcode data length is less than the Min length or more than the Max length, it will not be able to read this code. Default "0" represents no limits on barcode length.

LenMin



LenMax



Procedure:

- (A) Scan "Enter" barcode
- (B) Scan "LenMin" or "LenMax" barcode
- (C) Scan parameters from Hexadecimal / Decimal table
- (D) Scan "OK" barcode
- (E) Scan "End" barcode

8-9-6 Truncate Leading Characters

This enables to truncate the barcode data from the beginning of the barcode



Procedure:

- (A) Scan "Enter" barcode
- (B) Scan "Truncate Leading Characters" barcode
- (C) Scan parameters from Hexadecimal / Decimal table
- (D) Scan "OK" barcode
- (E) Scan "End" barcode

Enter



250

End



8-9-7 Truncate Trailing Characters

This enables to truncate the barcode data from the Ending of the barcode

**Procedure:**

- (A) Scan "Enter" barcode
- (B) Scan "Truncate Trailing Characters" barcode
- (C) Scan parameters from Hexadecimal / Decimal table
- (D) Scan "OK" barcode
- (E) Scan "End" barcode

8-9-8 Position for Inserting

The position of the data insertion, if the insertion data position is in the first position of the barcode data, specify as 0. If the insertion data position is behind the barcode data, specify as 255. (Range:0-255)

Ins0Pos



Ins1Pos

**Procedure:**

- (A) Scan "Enter" barcode
- (B) Scan "Ins0Pos" or "Ins1Pos" barcode
- (C) Scan parameters from Hexadecimal / Decimal table
- (D) Scan "OK" barcode
- (E) Scan "End" barcode

Enter



251

End



8-9-9 Position for Inserting characters

User can specify the characters in the Insert Position

Ins0PosChar



Ins1PosChar



Procedure:

- (A) Scan "Enter" barcode
- (B) Scan "Ins0Poschar" or "Ins1Poschar" barcode
- (C) Scan parameters from Hexadecimal / Decimal table
- (D) Scan "OK" barcode
- (E) Scan "End" barcode

8-9-10 Code ID for Interleaved 2 of 5

Code ID set barcode



Procedure:

- (A) Scan "Enter" barcode
- (B) Scan "Code ID for Interleaved 2 of 5" barcode
- (C) Scan parameters from Hexadecimal / Decimal table
- (D) Scan "OK" barcode
- (E) Scan "End" barcode

Enter



252

End



8-10 Industrial 2 of 5

8-10-1 Read

Industrial 2 of 5 barcode symbology configuration.

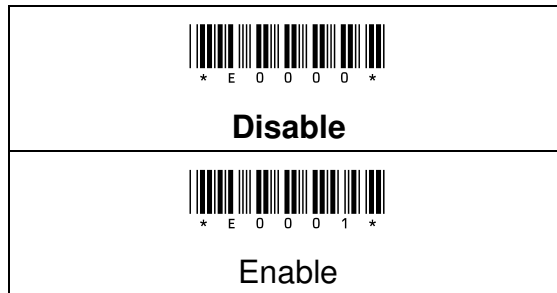

8-10- 2 Checksum Verification

The option enables to verify the check digits, if this option is enable, any barcodes without check digits will not be able to scan
 The checksum is made the sum module 10 as the numerical values of all data digits.

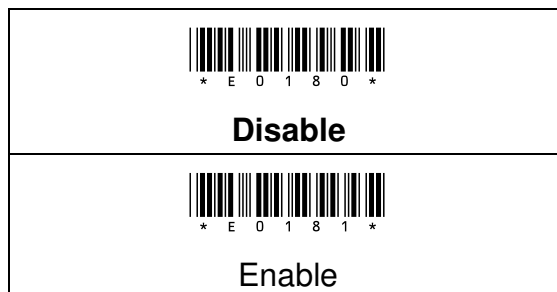

8-10-3 Transmission Checksum

The option enables to display the check digits.

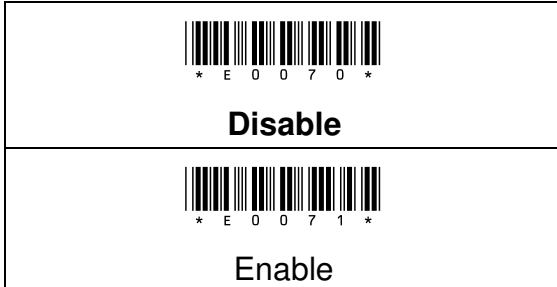

8-10-4 Truncate Leading Zeros

When the barcode leading have "0", you can configured this function to truncate all leading "0" of barcode.

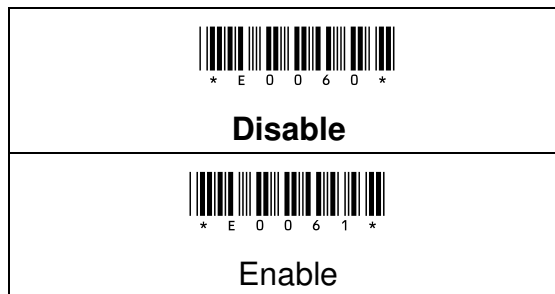

8-10-5 Min/Max Code Length

If barcode data length is less than the Min length or more than the Max length, it will not be able to read this code. Default "0" represents no limits on barcode length.

LenMin



LenMax



Procedure:

- (A) Scan "Enter" barcode
- (B) Scan "LenMin" or "LenMax" barcode
- (C) Scan parameters from Hexadecimal / Decimal table
- (D) Scan "OK" barcode
- (E) Scan "End" barcode

8-10-6 Truncate Leading Characters

This enables to truncate the barcode data from the beginning of the barcode



Procedure:

- (A) Scan "Enter" barcode
- (B) Scan "Truncate Leading Characters" barcode
- (C) Scan parameters from Hexadecimal / Decimal table
- (D) Scan "OK" barcode
- (E) Scan "End" barcode

Enter



255

End



8-10-7 Truncate Trailing Characters

This enables to truncate the barcode data from the Ending of the barcode



Procedure:

- (A) Scan "Enter" barcode
- (B) Scan "Truncate Trailing Characters" barcode
- (C) Scan parameters from Hexadecimal / Decimal table
- (D) Scan "OK" barcode
- (E) Scan "End" barcode

8-10-8 Position for Inserting

The position of the data insertion, if the insertion data position is in the first position of the barcode data, specify as 0. If the insertion data position is behind the barcode data, specify as 255. (Range:0-255)

Ins0Pos



Ins1Pos



Procedure:

- (A) Scan "Enter" barcode
- (B) Scan "Ins0Pos" or "Ins1Pos" barcode
- (C) Scan parameters from Hexadecimal / Decimal table
- (D) Scan "OK" barcode
- (E) Scan "End" barcode

Enter



256

End



8-10-9 Position for Inserting characters

User can specify the characters in the Insert Position

Ins0PosChar



Ins1PosChar



Procedure:

- (A) Scan "Enter" barcode
- (B) Scan "Ins0Poschar" or "Ins1Poschar" barcode
- (C) Scan parameters from Hexadecimal / Decimal table
- (D) Scan "OK" barcode
- (E) Scan "End" barcode

8-10-10 Code ID for Industrial 2 of 5

Code ID set barcode



Procedure:

- (A) Scan "Enter" barcode
- (B) Scan "Code ID for Industrial 2 of 5" barcode
- (C) Scan parameters from Hexadecimal / Decimal table
- (D) Scan "OK" barcode
- (E) Scan "End" barcode

Enter



257

End



8- 11 Matrix 2 of 5

8- 11 - 1 Read

Matrix 2 of 5 barcode symbology configuration.

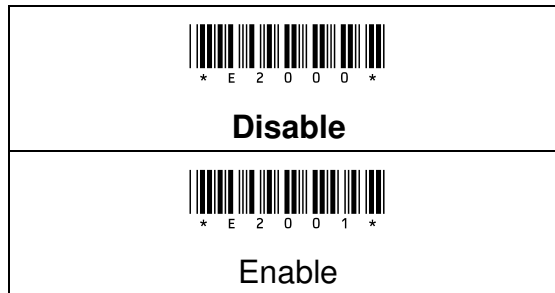

8-11 2 Checksum Verification

The option enables to verify the check digits, if this option is enable, any barcodes without check digits will not be able to scan.

The checksum is made the sum module 10 as the numerical values of all data digits.

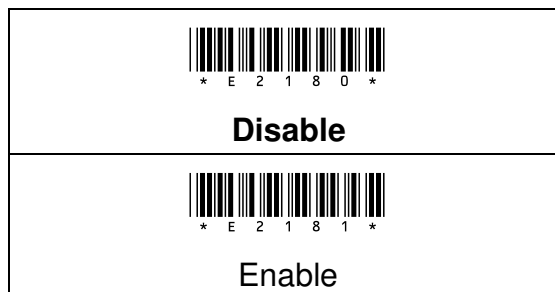

8-11-3 Transmission Checksum

The option enables to display the check digits.

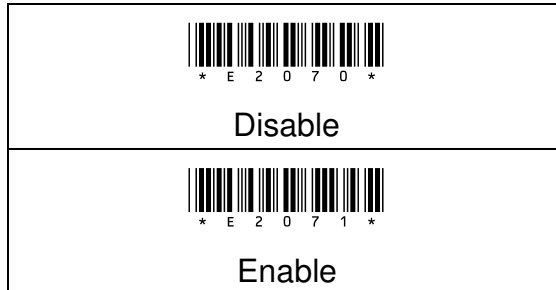

8-11-4 Truncate Leading Zeros

When the barcode leading have "0", you can configured this function to truncate all leading "0" of barcode.

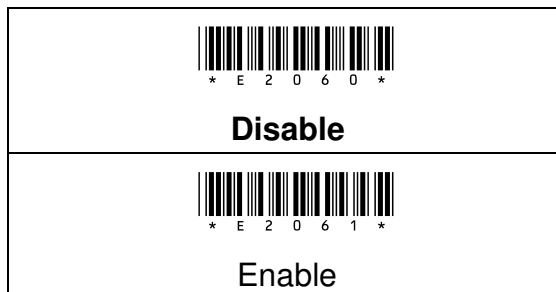

8-11-5 Min/Max Code Length

If barcode data length is less than the Min length or more than the Max length, it will not be able to read this code. Default "0" represents no limits on barcode length.

LenMin



LenMax



Procedure:

- (A) Scan "Enter" barcode
- (B) Scan "LenMin" or "LenMax" barcode
- (C) Scan parameters from Hexadecimal / Decimal table
- (D) Scan "OK" barcode
- (E) Scan "End" barcode

8-11-6 Truncate Leading Characters

This enables to truncate the barcode data from the beginning of the barcode



Procedure:

- (A) Scan "Enter" barcode
- (B) Scan "Truncate Leading Characters" barcode
- (C) Scan parameters from Hexadecimal / Decimal table
- (D) Scan "OK" barcode
- (E) Scan "End" barcode

Enter



260

End



8-11-7 Truncate Trailing Characters

This enables to truncate the barcode data from the Ending of the barcode

**Procedure:**

- (A) Scan "Enter" barcode
- (B) Scan "Truncate Trailing Characters" barcode
- (C) Scan parameters from Hexadecimal / Decimal table
- (D) Scan "OK" barcode
- (E) Scan "End" barcode

8-11-8 Position for Inserting

The position of the data insertion, if the insertion data position is in the first position of the barcode data, specify as 0. If the insertion data position is behind the barcode data, specify as 255. (Range:0-255)

Ins0Pos



Ins1Pos

**Procedure:**

- (A) Scan "Enter" barcode
- (B) Scan "Ins0Pos" or "Ins1Pos" barcode
- (C) Scan parameters from Hexadecimal / Decimal table
- (D) Scan "OK" barcode
- (E) Scan "End" barcode

Enter



261

End



8-11-9 Position for Inserting characters

User can specify the characters in the Insert Position

Ins0PosChar



Ins1PosChar



Procedure:

- (A) Scan "Enter" barcode
- (B) Scan "Ins0Poschar" or "Ins1Poschar" barcode
- (C) Scan parameters from Hexadecimal / Decimal table
- (D) Scan "OK" barcode
- (E) Scan "End" barcode

8-11-10 Code ID for Matrix 2 of 5

Code ID set barcode



Procedure:

- (A) Scan "Enter" barcode
- (B) Scan "Code ID for Martrix 2 of 5" barcode
- (C) Scan parameters from Hexadecimal / Decimal table
- (D) Scan "OK" barcode
- (E) Scan "End" barcode

Enter



262

End



8- 12 Code 93

8- 12 - 1 Read

Code-93 barcode symbology configuration.

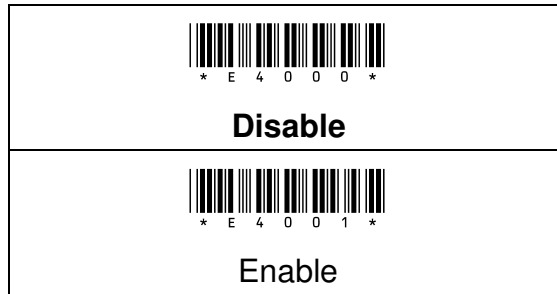

8- 12 - 2 Transmission Checksum

The option enables to display the check digits.

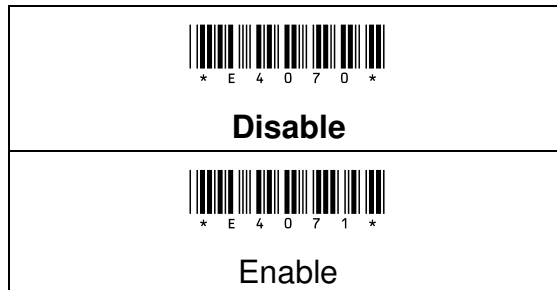

Enter



263

End



8- 12 - 3 Checksum Verification

The option enables to verify the check digits, if this option is enable, any barcodes without check digits will not be able to scan.

The checksum is presented as the sum module 47 of all data digits.

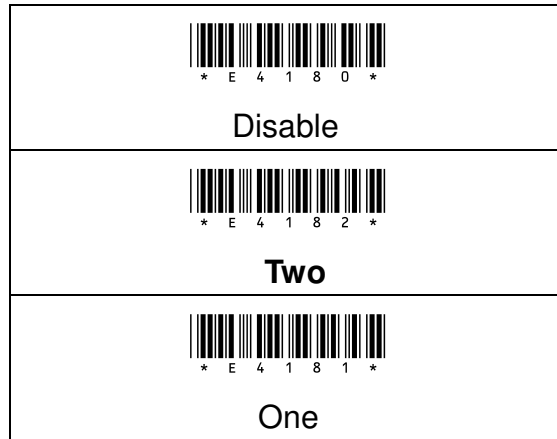

8-12-4 Truncate Leading Zeros

When the barcode leading have "0", you can configured this function to truncate all leading "0" of barcode.

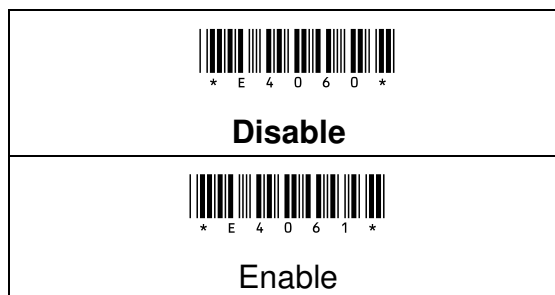

Enter



264

End



8-12-5 Min/Max Code Length

If barcode data length is less than the Min length or more than the Max length, it will not be able to read this code. Default "0" represents no limits on barcode length.

LenMin



LenMax



Procedure:

- (A) Scan "Enter" barcode
- (B) Scan "LenMin" or "LenMax" barcode
- (C) Scan parameters from Hexadecimal / Decimal table
- (D) Scan "OK" barcode
- (E) Scan "End" barcode

8-12-6 Truncate Leading Characters

This enables to truncate the barcode data from the beginning of the barcode



Procedure:

- (A) Scan "Enter" barcode
- (B) Scan "Truncate Leading Characters" barcode
- (C) Scan parameters from Hexadecimal / Decimal table
- (D) Scan "OK" barcode
- (E) Scan "End" barcode

Enter



265

End



8-12-7 Truncate Trailing Characters

This enables to truncate the barcode data from the Ending of the barcode

**Procedure:**

- (A) Scan "Enter" barcode
- (B) Scan "Truncate Trailing Characters" barcode
- (C) Scan parameters from Hexadecimal / Decimal table
- (D) Scan "OK" barcode
- (E) Scan "End" barcode

8-12-8 Position for Inserting

The position of the data insertion, if the insertion data position is in the first position of the barcode data, specify as 0. If the insertion data position is behind the barcode data, specify as 255. (Range:0-255)

Ins0Pos



Ins1Pos

**Procedure:**

- (A) Scan "Enter" barcode
- (B) Scan "Ins0Pos" or "Ins1Pos" barcode
- (C) Scan parameters from Hexadecimal / Decimal table
- (D) Scan "OK" barcode
- (E) Scan "End" barcode

Enter



266

End



8-12-9 Position for Inserting characters

User can specify the characters in the Insert Position

Ins0PosChar



Ins1PosChar



Procedure:

- (A) Scan "Enter" barcode
- (B) Scan "Ins0Poschar" or "Ins1Poschar" barcode
- (C) Scan parameters from Hexadecimal / Decimal table
- (D) Scan "OK" barcode
- (E) Scan "End" barcode

8-12-10 Code ID for Code 93

Code ID set Barcode



Procedure:

- (A) Scan "Enter" barcode
- (B) Scan "Code ID for Code 93" barcode
- (C) Scan parameters from Hexadecimal / Decimal table
- (D) Scan "OK" barcode
- (E) Scan "End" barcode

Enter



267

End



8- 13 Code 11

8- 13 - 1 Read

Code 11 barcode symbology configuration.

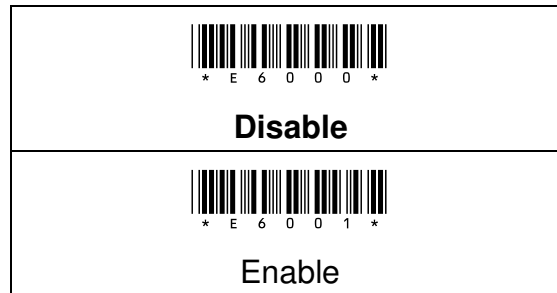

8- 13 - 2 Checksum Transmission

The option enables to verify the check digits, if this option is enable, any barcodes without check digits will not be able to scan.

By setting Enable, checksum1 and checksum2 will be transmitted upon your selected checksum verification method.

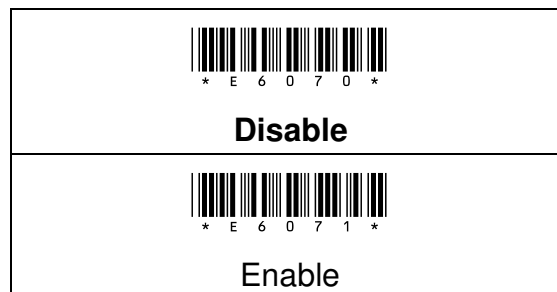

Enter





268

End





8- 13 - 3 Checksum Verification

The checksum is presented as the sum module 11 of all data digits.

 * E 6 1 8 0 * Disable
 * E 6 1 8 2 * Two
 * E 6 1 8 1 * One

8-13-4 Truncate Leading Zeros

When the barcode leading have "0", you can configured this function to truncate all leading "0" of barcode.

 * E 6 0 6 0 * Disable
 * E 6 0 6 1 * Enable

Enter



269

End



8-13-5 Min/Max Code Length

If barcode data length is less than the Min length or more than the Max length, it will not be able to read this code. Default "0" represents no limits on barcode length.

LenMin



LenMax



Procedure:

- (A) Scan "Enter" barcode
- (B) Scan "LenMin" or "LenMax" barcode
- (C) Scan parameters from Hexadecimal / Decimal table
- (D) Scan "OK" barcode
- (E) Scan "End" barcode

8-13-6 Truncate Leading Characters

This enables to truncate the barcode data from the beginning of the barcode



Procedure:

- (A) Scan "Enter" barcode
- (B) Scan "Truncate Leading Characters" barcode
- (C) Scan parameters from Hexadecimal / Decimal table
- (D) Scan "OK" barcode
- (E) Scan "End" barcode

Enter



270

End



8-13-7 Truncate Trailing Characters

This enables to truncate the barcode data from the Ending of the barcode

**Procedure:**

- (A) Scan “Enter” barcode
- (B) Scan “Truncate Trailing Characters” barcode
- (C) Scan parameters from Hexadecimal / Decimal table
- (D) Scan “OK” barcode
- (E) Scan “End” barcode

8-13-8 Position for Inserting

The position of the data insertion, if the insertion data position is in the first position of the barcode data, specify as 0. If the insertion data position is behind the barcode data, specify as 255. (Range:0-255)

Ins0Pos



Ins1Pos

**Procedure:**

- (A) Scan “Enter” barcode
- (B) Scan “Ins0Pos” or “Ins1Pos” barcode
- (C) Scan parameters from Hexadecimal / Decimal table
- (D) Scan “OK” barcode
- (E) Scan “End” barcode

Enter



271

End



8-13-9 Position for Inserting characters

User can specify the characters in the Insert Position

Ins0PosChar



Ins1PosChar



Procedure:

- (A) Scan "Enter" barcode
- (B) Scan "Ins0Poschar" or "Ins1Poschar" barcode
- (C) Scan parameters from Hexadecimal / Decimal table
- (D) Scan "OK" barcode
- (E) Scan "End" barcode

8-13-10 Code ID for Code 11

Code ID set Barcode



Procedure:

- (A) Scan "Enter" barcode
- (B) Scan "Code ID for Code 11" barcode
- (C) Scan parameters from Hexadecimal / Decimal table
- (D) Scan "OK" barcode
- (E) Scan "End" barcode

Enter



272



End



8- 14 MSI / Plessey



8- 14 - 1 Read

MSI / Plessey barcode symbology configuration

 Disable
 Enable

8- 14 - 2 Transmission Checksum

The option enables to display the check digits.

 Disable
 Enable

Enter



273





End



8- 14 - 3 Checksum Verification

The option enables to verify the check digits, if this option is enable, any barcodes without check digits will not be able to scan.

The MSI/Plessey has one or two optional checksum characters. The checksum is presented by 3 kinds of method as Mod 10, Mod 10/10 and Mod 11/10. The checksum1 and checksum2 will be calculated as the sum module 10 or 11 of the data digits.

 * E 8 1 8 0 *
Disable
 * E 8 1 8 1 *
Mod 10
 * E 8 1 8 2 *
Mod 10/10
 * E 8 1 8 3 *
Mod 11/10



8-14-4 Truncate Leading Zeros

When the barcode leading have “0”, you can configured this function to truncate all leading “0” of barcode.

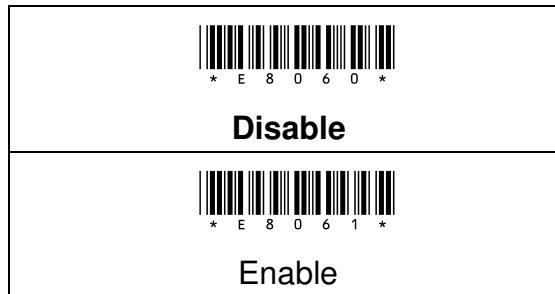

8-14-5 Min/Max Code Length

If barcode data length is less then the Min length or more then the Max length, it will not be able to read this code. Default “0” represents no limits on barcode length.

LenMin



LenMax

**Procedure:**

- (A) Scan “Enter” barcode
- (B) Scan “LenMin” or “LenMax” barcode
- (C) Scan parameters from Hexadecimal / Decimal table
- (D) Scan “OK” barcode
- (E) Scan “End” barcode

Enter



275

End



8-14-6 Truncate Leading Characters

This enables to truncate the barcode data from the beginning of the barcode



Procedure:

- (A) Scan "Enter" barcode
- (B) Scan "Truncate Leading Characters" barcode
- (C) Scan parameters from Hexadecimal / Decimal table
- (D) Scan "OK" barcode
- (E) Scan "End" barcode

8-14-7 Truncate Trailing Characters

This enables to truncate the barcode data from the Ending of the barcode



Procedure:

- (A) Scan "Enter" barcode
- (B) Scan "Truncate Trailing Characters" barcode
- (C) Scan parameters from Hexadecimal / Decimal table
- (D) Scan "OK" barcode
- (E) Scan "End" barcode

Enter



276

End



8-14-8 Position for Inserting

The position of the data insertion, if the insertion data position is in the first position of the barcode data, specify as 0. If the insertion data position is behind the barcode data, specify as 255. (Range:0-255)

Ins0Pos



Ins1Pos



Procedure:

- (A) Scan "Enter" barcode
- (B) Scan "Ins0Pos" or "Ins1Pos" barcode
- (C) Scan parameters from Hexadecimal / Decimal table
- (D) Scan "OK" barcode
- (E) Scan "End" barcode

8-14-9 Position for Inserting characters

User can specify the characters in the Insert Position

Ins0PosChar



Ins1PosChar



Procedure:

- (A) Scan "Enter" barcode
- (B) Scan "Ins0Poschar" or "Ins1Poschar" barcode
- (C) Scan parameters from Hexadecimal / Decimal table
- (D) Scan "OK" barcode
- (E) Scan "End" barcode

Enter



277

End



8-14-10 Code ID for MSI/Plessey

Code ID set Barcode



Procedure:

- (A) Scan "Enter" barcode
- (B) Scan "Code ID for MSI/Plessey" barcode
- (C) Scan parameters from Hexadecimal / Decimal table
- (D) Scan "OK" barcode
- (E) Scan "End" barcode

Enter



278

End



8- 15 UK / Plessey

8- 15 - 1 Read

UK/ Plessey barcode symbology configuration

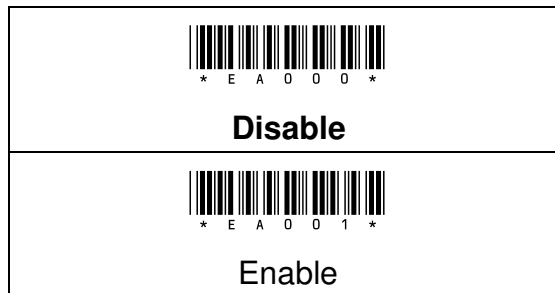

8- 15 - 2 Verify Checksum

The option enables to verify the check digits, if this option is enable, any barcodes without check digits will not be able to scan.

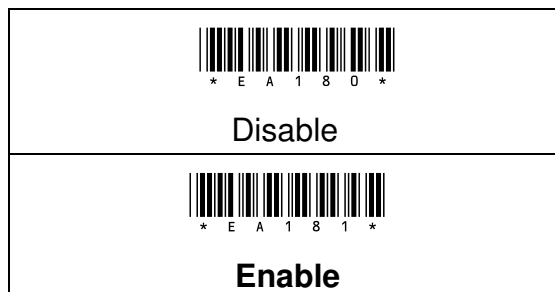

Enter



279

End



8- 15 - 3 Transmission Checksum

The option enables to display the check digits.

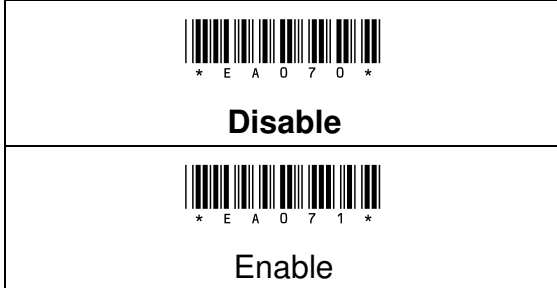

8-15-4 Truncate Leading Zeros

When the barcode leading have "0", you can configured this function to truncate all leading "0" of barcode.

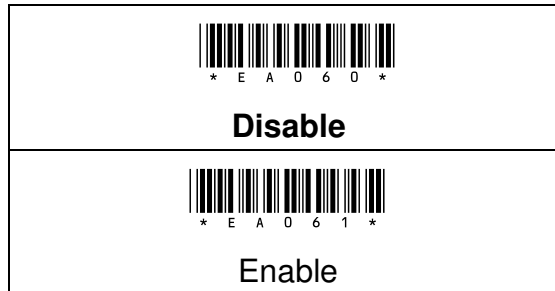

8-15-5 Min/Max Code Length

If barcode data length is less than the Min length or more than the Max length, it will not be able to read this code. Default "0" represents no limits on barcode length.

LenMin



LenMax



Procedure:

- (A) Scan "Enter" barcode
- (B) Scan "LenMin" or "LenMax" barcode
- (C) Scan parameters from Hexadecimal / Decimal table
- (D) Scan "OK" barcode
- (E) Scan "End" barcode

8-15-6 Truncate Leading Characters

This enables to truncate the barcode data from the beginning of the barcode



Procedure:

- (A) Scan "Enter" barcode
- (B) Scan "Truncate Leading Characters" barcode
- (C) Scan parameters from Hexadecimal / Decimal table
- (D) Scan "OK" barcode
- (E) Scan "End" barcode

Enter



281

End



8-15-7 Truncate Trailing Characters

This enables to truncate the barcode data from the Ending of the barcode



Procedure:

- (A) Scan "Enter" barcode
- (B) Scan "Truncate Trailing Characters" barcode
- (C) Scan parameters from Hexadecimal / Decimal table
- (D) Scan "OK" barcode
- (E) Scan "End" barcode

8-15-8 Position for Inserting

The position of the data insertion, if the insertion data position is in the first position of the barcode data, specify as 0. If the insertion data position is behind the barcode data, specify as 255. (Range:0-255)

Ins0Pos



Ins1Pos



Procedure:

- (A) Scan "Enter" barcode
- (B) Scan "Ins0Pos" or "Ins1Pos" barcode
- (C) Scan parameters from Hexadecimal / Decimal table
- (D) Scan "OK" barcode
- (E) Scan "End" barcode

Enter



282

End



8-15-9 Position for Inserting characters

User can specify the characters in the Insert Position

Ins0PosChar



Ins1PosChar



Procedure:

- (A) Scan "Enter" barcode
- (B) Scan "Ins0Poschar" or "Ins1Poschar" barcode
- (C) Scan parameters from Hexadecimal / Decimal table
- (D) Scan "OK" barcode
- (E) Scan "End" barcode

8-15-10 Code ID for UK/Plessey

Code ID set Barcode



Procedure:

- (A) Scan "Enter" barcode
- (B) Scan "Code ID for UK/Plessey" barcode
- (C) Scan parameters from Hexadecimal / Decimal table
- (D) Scan "OK" barcode
- (E) Scan "End" barcode

Enter



283

End



8- 16 Telepen

8- 16 - 1 Read

Telepen barcode symbology configuration

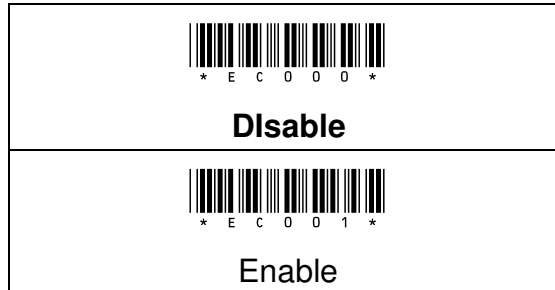

8- 16 - 2 Checksum Verification

The option enables to verify the check digits, if this option is enable, any barcodes without check digits will not be able to scan.

The option enables to verify the check digits, if this option is enable, any barcodes without check digits will not be able to scan.

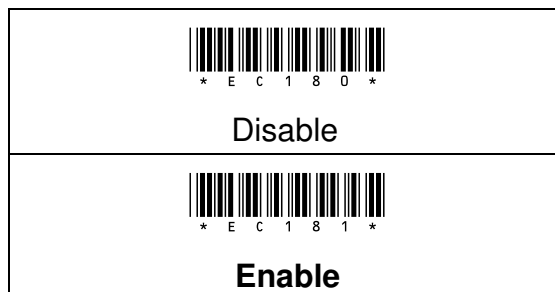

8- 16 - 3 Type

Telepen can be transmitted by Numeric and ASCII format. Characters can be mixed the both format in Telepen barcode. By setting Auto Switching, data can be converted between Numeric and Full ASCII by character (7F₁₆)automatically.

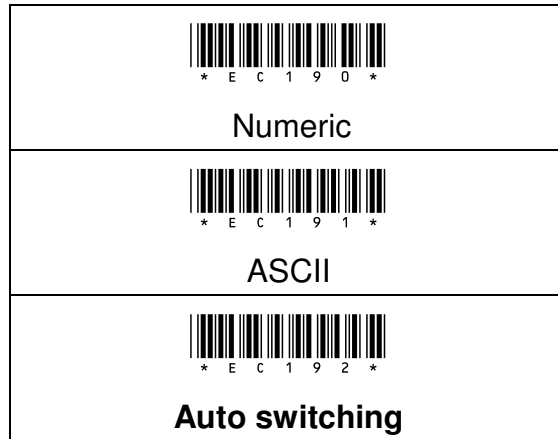

8- 16 - 4 Transmission Checksum

The option enables to display the check digits

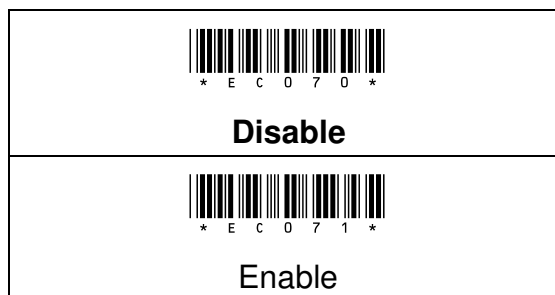

8-16-5 Truncate Leading Zeros

When the barcode leading have “0”, you can configured this function to truncate all leading “0” of barcode.

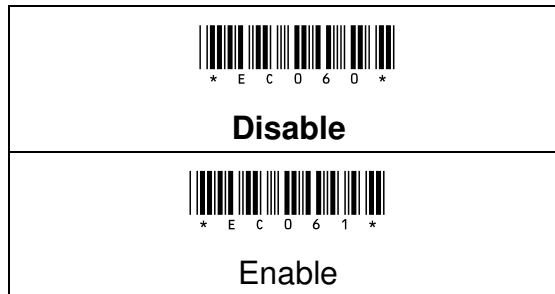

8-16-6 Min/Max Code Length

If barcode data length is less then the Min length or more then the Max length, it will not be able to read this code. Default “0” represents no limits on barcode length.

LenMin



LenMax

**Procedure:**

- (A) Scan “Enter” barcode
- (B) Scan “LenMin” or “LenMax” barcode
- (C) Scan parameters from Hexadecimal / Decimal table
- (D) Scan “OK” barcode
- (E) Scan “End” barcode

Enter



286

End



8-16-7 Truncate Leading Characters

This enables to truncate the barcode data from the beginning of the barcode



Procedure:

- (A) Scan "Enter" barcode
- (B) Scan "Leading Characters" barcode
- (C) Scan parameters from Hexadecimal / Decimal table
- (D) Scan "OK" barcode
- (E) Scan "End" barcode

8-16-8 Truncate Trailing Characters

This enables to truncate the barcode data from the Ending of the barcode



Procedure:

- (A) Scan "Enter" barcode
- (B) Scan "Truncate Trailing Characters" barcode
- (C) Scan parameters from Hexadecimal / Decimal table
- (D) Scan "OK" barcode
- (E) Scan "End" barcode

Enter



287

End



8-16-9 Position for Inserting

The position of the data insertion, if the insertion data position is in the first position of the barcode data, specify as 0. If the insertion data position is behind the barcode data, specify as 255. (Range:0-255)

Ins0Pos



Ins1Pos



Procedure:

- (A) Scan "Enter" barcode
- (B) Scan "Ins0Pos" or "Ins1Pos" barcode
- (C) Scan parameters from Hexadecimal / Decimal table
- (D) Scan "OK" barcode
- (E) Scan "End" barcode

8-16-10 Position for Inserting characters

User can specify the characters in the Insert Position

Ins0PosChar



Ins1PosChar



Procedure:

- (A) Scan "Enter" barcode
- (B) Scan "Ins0Poschar" or "Ins1Poschar" barcode
- (C) Scan parameters from Hexadecimal / Decimal table
- (D) Scan "OK" barcode
- (E) Scan "End" barcode

Enter



288

End



8-16-11 Code ID for Telepen

Code ID set Barcode



Procedure:

- (A) Scan "Enter" barcode
- (B) Scan "Code ID for Telepen" barcode
- (C) Scan parameters from Hexadecimal / Decimal table
- (D) Scan "OK" barcode
- (E) Scan "End" barcode

Enter



289

End



8- 17 RSS (GS1 DataBar) 14

8- 17 - 1 Read

RSS(GS1 DataBar)14 barcode symbology configuration

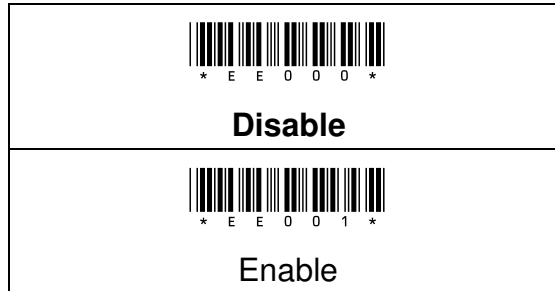

8- 17 - 2 Code Mark

For the output of “[e0”, Code Mark function needs to be Enable.

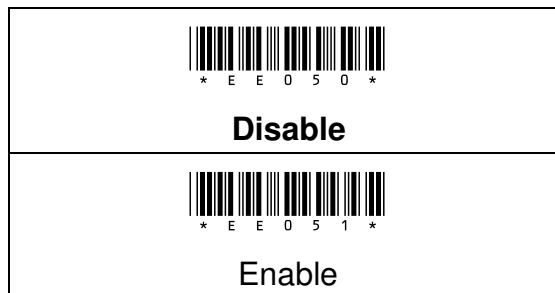

Enter



290

End



8- 17 - 3 Application ID

Whether to add "()" in ID code of barcode.

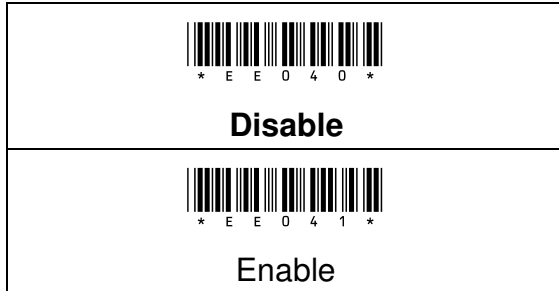

8- 17 - 4 Transmission Checksum

The option enables to display the check digits.

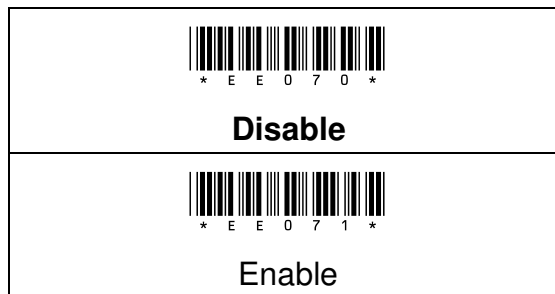

8-17-5 Truncate Leading Zeros

When the barcode leading have "0", you can configured this function to truncate all leading "0" of barcode.

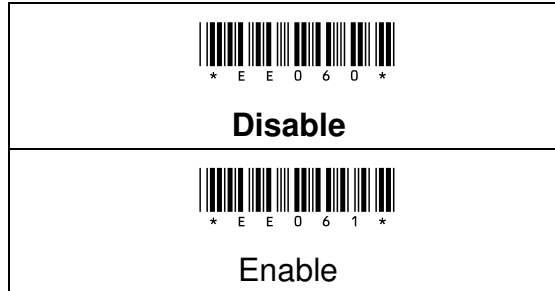

8-17-6 Truncate Leading Characters

This enables to truncate the barcode data from the beginning of the barcode

**Procedure:**

- (A) Scan "Enter" barcode
- (B) Scan "Truncate Leading Characters" barcode
- (C) Scan parameters from Hexadecimal / Decimal table
- (D) Scan "OK" barcode
- (E) Scan "End" barcode

Enter



292

End



8-17-7 Truncate Trailing Characters

This enables to truncate the barcode data from the Ending of the barcode

**Procedure:**

- (A) Scan "Enter" barcode
- (B) Scan "Truncate Trailing Characters" barcode
- (C) Scan parameters from Hexadecimal / Decimal table
- (D) Scan "OK" barcode
- (E) Scan "End" barcode

8-17-8 Position for Inserting

The position of the data insertion, if the insertion data position is in the first position of the barcode data, specify as 0. If the insertion data position is behind the barcode data, specify as 255. (Range:0-255)

Ins0Pos



Ins1Pos

**Procedure:**

- (A) Scan "Enter" barcode
- (B) Scan "Ins0Pos" or "Ins1Pos" barcode
- (C) Scan parameters from Hexadecimal / Decimal table
- (D) Scan "OK" barcode
- (E) Scan "End" barcode

Enter



293

End



8-17-9 Position for Inserting characters

User can specify the characters in the Insert Position

Ins0PosChar



Ins1PosChar



Procedure:

- (A) Scan "Enter" barcode
- (B) Scan "Ins0Poschar" or "Ins1Poschar" barcode
- (C) Scan parameters from Hexadecimal / Decimal table
- (D) Scan "OK" barcode
- (E) Scan "End" barcode

8-17-10 Code ID for Rss14

Code ID set Barcode



Procedure:

- (A) Scan "Enter" barcode
- (B) Scan "Code ID for Code 11" barcode
- (C) Scan parameters from Hexadecimal / Decimal table
- (D) Scan "OK" barcode
- (E) Scan "End" barcode

Enter



294

End



8- 18 RSS (GS1 DataBar) Limited

8- 18 - 1 Read

RSS(GS1 DataBar) Limited barcode symbology configuration.

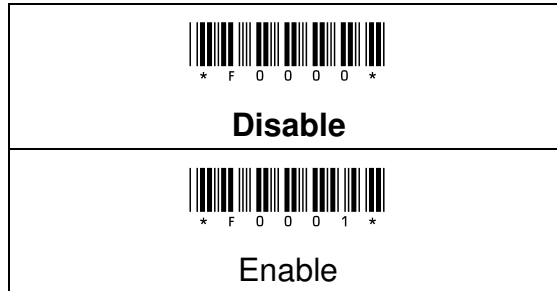

8- 18 - 2 Code Mark

For the output of “[e0”, Code Mark function needs to be Enable.

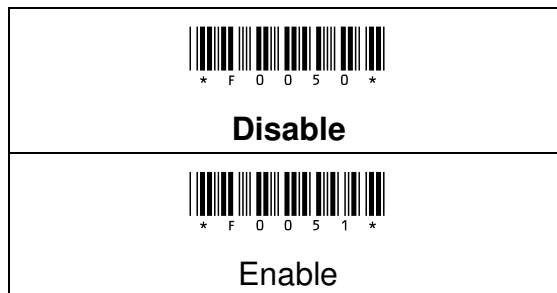

8- 18 - 3 Application ID

Whether to add "()" in ID code of barcode.

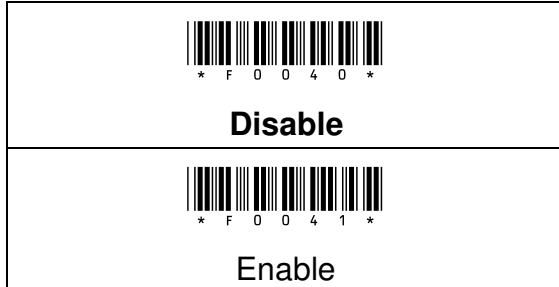

8- 18 - 4 Transmission Checksum

The option enables to display the check digits.

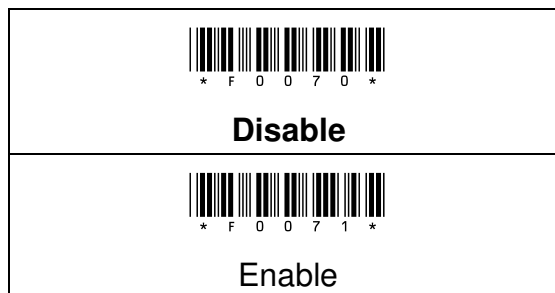

8-18-5 Truncate Leading Zeros

When the barcode leading have "0", you can configured this function to truncate all leading "0" of barcode.

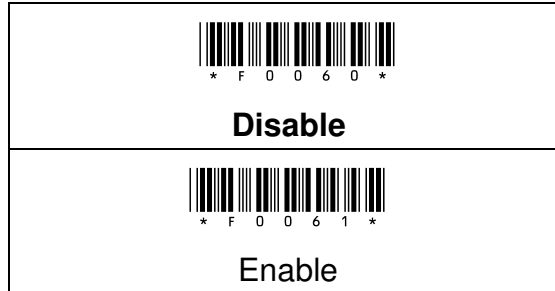

8-18-6 Truncate Leading Characters

This enables to truncate the barcode data from the beginning of the barcode

**Procedure:**

- (A) Scan "Enter" barcode
- (B) Scan "Truncate Leading Characters" barcode
- (C) Scan parameters from Hexadecimal / Decimal table
- (D) Scan "OK" barcode
- (E) Scan "End" barcode

Enter



297

End



8-18-7 Truncate Trailing Characters

This enables to truncate the barcode data from the Ending of the barcode

**Procedure:**

- (A) Scan “Enter” barcode
- (B) Scan “Truncate Trailing Characters” barcode
- (C) Scan parameters from Hexadecimal / Decimal table
- (D) Scan “OK” barcode
- (E) Scan “End” barcode

8-18-8 Position for Inserting

The position of the data insertion, if the insertion data position is in the first position of the barcode data, specify as 0. If the insertion data position is behind the barcode data, specify as 255. (Range:0-255)

Ins0Pos



Ins1Pos

**Procedure:**

- (A) Scan “Enter” barcode
- (B) Scan “Ins0Pos” or “Ins1Pos” barcode
- (C) Scan parameters from Hexadecimal / Decimal table
- (D) Scan “OK” barcode
- (E) Scan “End” barcode

Enter



298

End



8-18-9 Position for Inserting characters

User can specify the characters in the Insert Position

Ins0PosChar



Ins1PosChar



Procedure:

- (A) Scan "Enter" barcode
- (B) Scan "Ins0Poschar" or "Ins1Poschar" barcode
- (C) Scan parameters from Hexadecimal / Decimal table
- (D) Scan "OK" barcode
- (E) Scan "End" barcode

8-18-10 Code ID for RssLimited

Code ID set Barcode



Procedure:

- (A) Scan "Enter" barcode
- (B) Scan "Code ID for RssLimited" barcode
- (C) Scan parameters from Hexadecimal / Decimal table
- (D) Scan "OK" barcode
- (E) Scan "End" barcode

Enter



299

End



8- 19 RSS (GS1 DataBar) 14 Stack

8- 19 - 1 Read

RSS (GS1 DataBar)14 Stack barcode symbology configuration.

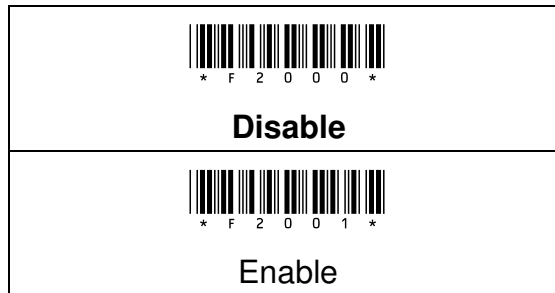

8- 19 - 2 Code Mark

For the output of “[e0” , Code Mark function needs to be Enable.

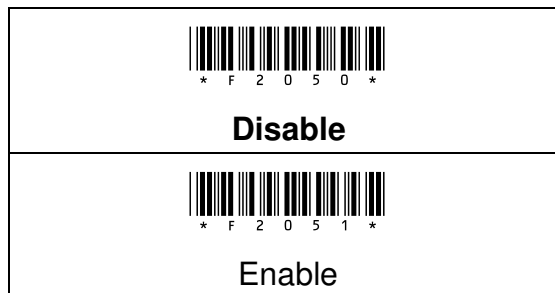

Enter





300

End





8- 19 - 3 Application ID

Whether to add "()" in ID code of barcode.

 * F 2 0 4 0 *
Disable
 * F 2 0 4 1 *
Enable

8- 19 - 4 Transmission Checksum

The option enables to display the check digits.

 * F 2 0 7 0 *
Disable
 * F 2 0 7 1 *
Enable



8-19-5 Truncate Leading Zeros

When the barcode leading have "0", you can configured this function to truncate all leading "0" of barcode.

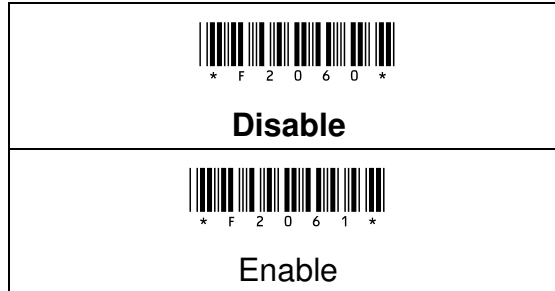

8-19-6 Truncate Leading Characters

This enables to truncate the barcode data from the beginning of the barcode

**Procedure:**

- (A) Scan "Enter" barcode
- (B) Scan "Truncate Leading Characters" barcode
- (C) Scan parameters from Hexadecimal / Decimal table
- (D) Scan "OK" barcode
- (E) Scan "End" barcode

Enter



302

End



8-19-7 Truncate Trailing Characters

This enables to truncate the barcode data from the Ending of the barcode



Procedure:

- (A) Scan "Enter" barcode
- (B) Scan "Truncate Trailing Characters" barcode
- (C) Scan parameters from Hexadecimal / Decimal table
- (D) Scan "OK" barcode
- (E) Scan "End" barcode

8-19-8 Position for Inserting

The position of the data insertion, if the insertion data position is in the first position of the barcode data, specify as 0. If the insertion data position is behind the barcode data, specify as 255. (Range:0-255)

Ins0Pos



Ins1Pos



Procedure:

- (A) Scan "Enter" barcode
- (B) Scan "Ins0Pos" or "Ins1Pos" barcode
- (C) Scan parameters from Hexadecimal / Decimal table
- (D) Scan "OK" barcode
- (E) Scan "End" barcode

Enter



303

End



8-19-9 Position for Inserting characters

User can specify the characters in the Insert Position

Ins0PosChar



Ins1PosChar



Procedure:

- (A) Scan "Enter" barcode
- (B) Scan "Ins0Poschar" or "Ins1Poschar" barcode
- (C) Scan parameters from Hexadecimal / Decimal table
- (D) Scan "OK" barcode
- (E) Scan "End" barcode

8-19-10 Code ID for Rss14 Stack

Code ID set Barcode



Procedure:

- (A) Scan "Enter" barcode
- (B) Scan "Code ID for Rss14 Stack" barcode
- (C) Scan parameters from Hexadecimal / Decimal table
- (D) Scan "OK" barcode
- (E) Scan "End" barcode

Enter



304

End



8- 20 RSS (GS1 DataBar) Expansion

8- 20 - 1 Read

RSS(GS1 DataBar) Expansion barcode symbology configuration.

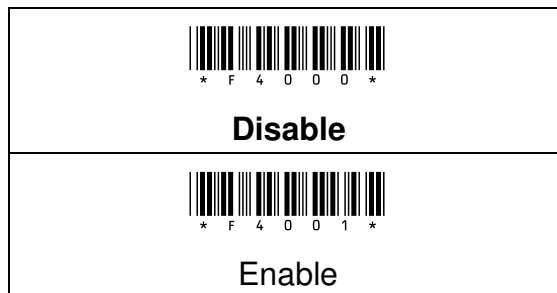

8- 20 - 2 Code Mark

For the output of “[e0” , Code Mark function must be Enable.

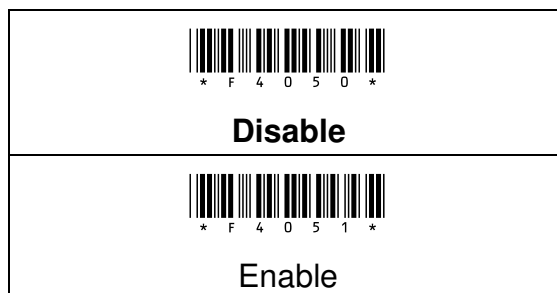

Enter





305

End





8- 20 - 3 Application ID

Whether to add "()" in ID code of barcode.

 * F 4 0 4 0 *
Disable
 * F 4 0 4 1 *
Enable

8- 20 - 4 Transmission Checksum

The option enables to display the check digits.

 * F 4 0 7 0 *
Disable
 * F 4 0 7 1 *
Enable

Enter



306

End



8-20-5 Truncate Leading Zeros

When the barcode leading have "0", you can configured this function to truncate all leading "0" of barcode.

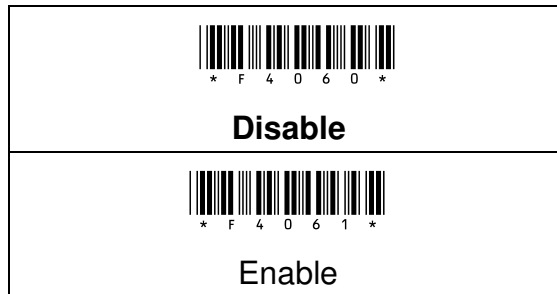

8-20-6 Truncate Leading Characters

This enables to truncate the barcode data from the beginning of the barcode



Procedure:

- (A) Scan "Enter" barcode
- (B) Scan "Truncate Leading Characters" barcode
- (C) Scan parameters from Hexadecimal / Decimal table
- (D) Scan "OK" barcode
- (E) Scan "End" barcode

Enter



307

End



8-20-7 Truncate Trailing Characters

This enables to truncate the barcode data from the Ending of the barcode



Procedure:

- (A) Scan "Enter" barcode
- (B) Scan "Truncate Trailing Characters" barcode
- (C) Scan parameters from Hexadecimal / Decimal table
- (D) Scan "OK" barcode
- (E) Scan "End" barcode

8-20-8 Position for Inserting

The position of the data insertion, if the insertion data position is in the first position of the barcode data, specify as 0. If the insertion data position is behind the barcode data, specify as 255. (Range:0-255)

Ins0Pos



Ins1Pos



Procedure:

- (A) Scan "Enter" barcode
- (B) Scan "Ins0Pos" or "Ins1Pos" barcode
- (C) Scan parameters from Hexadecimal / Decimal table
- (D) Scan "OK" barcode
- (E) Scan "End" barcode

Enter



308

End



8-20-9 Position for Inserting characters

User can specify the characters in the Insert Position

Ins0PosChar



Ins1PosChar



Procedure:

- (A) Scan "Enter" barcode
- (B) Scan "Ins0Poschar" or "Ins1Poschar" barcode
- (C) Scan parameters from Hexadecimal / Decimal table
- (D) Scan "OK" barcode
- (E) Scan "End" barcode

8-20-10 Code ID for Rss Expansion

Code ID set Barcode



Procedure:

- (A) Scan "Enter" barcode
- (B) Scan "Code ID for Rss1Expansion" barcode
- (C) Scan parameters from Hexadecimal / Decimal table
- (D) Scan "OK" barcode
- (E) Scan "End" barcode

Enter



309

End



8- 21 RSS (GS1 DataBar) Expansion Stack

8- 21 - 1 Read

RSS(GS1 DataBar) Expansion barcode symbology configuration.

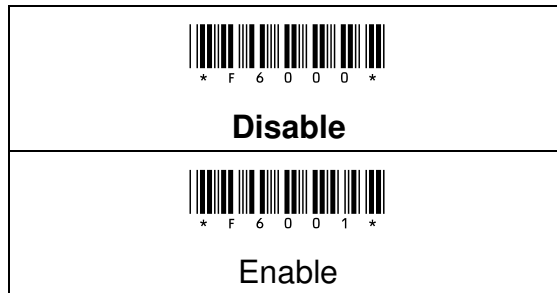

8- 21 - 2 Code Mark

For the output of “[e0” , Code Mark function must be Enable.

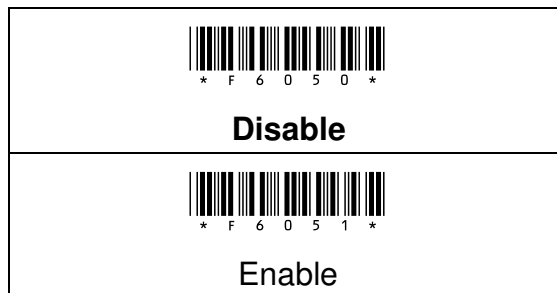

Enter



310

End



8- 21 - 3 Application ID

Whether to add "()" in ID code of barcode.

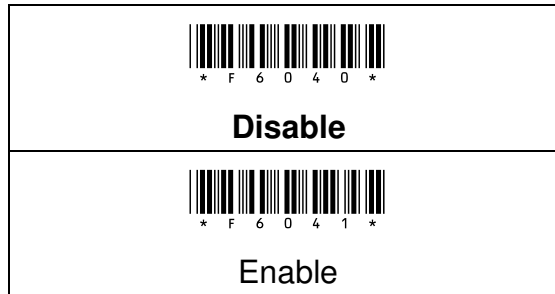

8- 21 - 4 Transmission Checksum

The option enables to display the check digits.

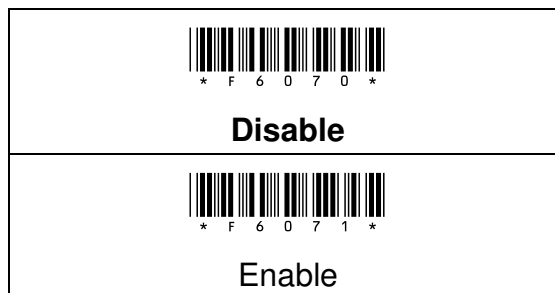

Enter



311

End



8-21-5 Truncate Leading Zeros

When the barcode leading have "0", you can configured this function to truncate all leading "0" of barcode.

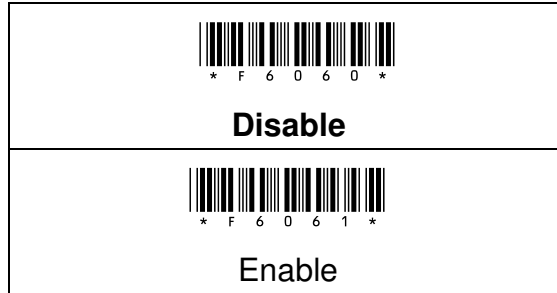

8-21-6 Truncate Leading Characters

This enables to truncate the barcode data from the beginning of the barcode



Procedure:

- (A) Scan "Enter" barcode
- (B) Scan "Truncate Leading Characters" barcode
- (C) Scan parameters from Hexadecimal / Decimal table
- (D) Scan "OK" barcode
- (E) Scan "End" barcode

Enter



312

End



8-21-7 Truncate Trailing Characters

This enables to truncate the barcode data from the Ending of the barcode

**Procedure:**

- (A) Scan “Enter” barcode
- (B) Scan “Truncate Trailing Characters” barcode
- (C) Scan parameters from Hexadecimal / Decimal table
- (D) Scan “OK” barcode
- (E) Scan “End” barcode

8-21-8 Position for Inserting

The position of the data insertion, if the insertion data position is in the first position of the barcode data, specify as 0. If the insertion data position is behind the barcode data, specify as 255. (Range:0-255)

Ins0Pos



Ins1Pos

**Procedure:**

- (A) Scan “Enter” barcode
- (B) Scan “Ins0Pos” or “Ins1Pos” barcode
- (C) Scan parameters from Hexadecimal / Decimal table
- (D) Scan “OK” barcode
- (E) Scan “End” barcode

Enter



313

End



8-21-9 Position for Inserting characters

User can specify the characters in the Insert Position

Ins0PosChar



Ins1PosChar



Procedure:

- (A) Scan "Enter" barcode
- (B) Scan "Ins0Poschar" or "Ins1Poschar" barcode
- (C) Scan parameters from Hexadecimal / Decimal table
- (D) Scan "OK" barcode
- (E) Scan "End" barcode

8-21-10 Code ID for Rss Expansion Stack

Code ID set Barcode



Procedure:

- (A) Scan "Enter" barcode
- (B) Scan "Code ID for Rss1Expansion" barcode
- (C) Scan parameters from Hexadecimal / Decimal table
- (D) Scan "OK" barcode
- (E) Scan "End" barcode

Enter



314

End



Appendix: Hexadecimal / Decimal Table

Hexadecimal / Decimal TABLE



* % 0 0 *

0



* % 0 1 *

1



* % 0 2 *

2



* % 0 3 *

3



* % 0 4 *

4



* % 0 5 *

5



* % 0 6 *

6



* % 0 7 *

7



* % 0 8 *

8



* % 0 9 *

9



* % 0 A *

A



* % 0 B *

B



* % 0 C *

C



* % 0 D *

D



* % 0 E *

E



* % 0 F *

F



* % 0 K *

OK

Enter



315

End



Appendix: ASCII Code Table

L ^H	2	3	4	5	6	7
0	SP	0	@	P	`	p
1	!	1	A	Q	a	q
2	“	2	B	R	b	r
3	#	3	C	S	c	s
4	\$	4	D	T	d	t
5	%	5	E	U	e	u
6	&	6	F	V	f	v
7	‘	7	G	W	g	w
8	(8	H	X	h	x
9)	9	I	Y	i	y
A	*	:	J	Z	j	z
B	+	;	K	[k	{
C	,	<	L	\	l	
D	-	=	M]	m	}
E	.	>	N	^	n	~
F	/	?	O	_	o	DEL

L ^H	0 (*)	1 (*)	0	1
0	Null		NUL	DLE
1	Up	F1	SOH	DC1
2	Down	F2	STX	DC2
3	Left	F3	ETX	DC3
4	Right	F4	EOT	DC4
5	PgUp	F5	ENQ	NAK
6	PgDn	F6	ACK	SYN
7		F7	BEL	ETB
8	Bs	F8	BS	CAN
9	Tab	F9	HT	EM
A		F10	LF	SUM
B	Home	Esc	VT	ESC
C	End	F11	FF	FS
D	Enter	F12	CR	GS
E	Insert	Ctrl+	SO	RS
F	Delete	Alt+	SI	US

(*) For keyboard wedge only.

